

ENERGIZER CR2025

Lithium Coin



Industry Standard Dimensions

mm (inches)

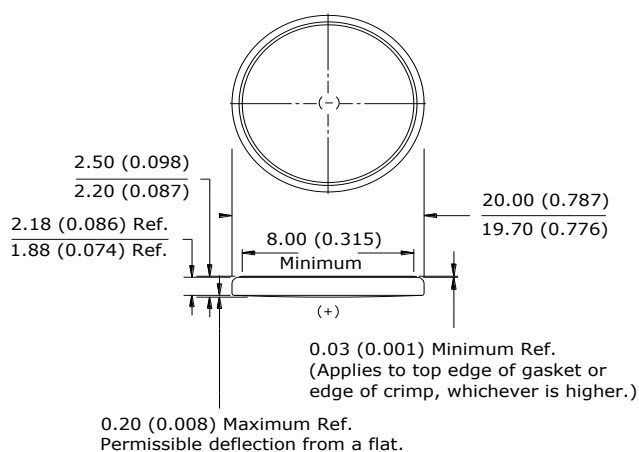

Simulated Application test

Typical Performance at 21°C (70°F)

Schedule:	Typical Drains: at 2.9V (mA)	Load (ohms)	Cutoff 2.0V (hours)
Continuous	0.193	15,000	845

Typical Discharge Characteristics

Load: 15K ohms - Continuous
Typical Drain @ 2.9V: 0.193 mA

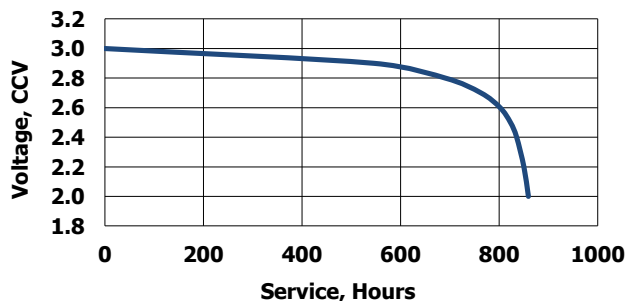

Internal Resistance Characteristics

Pulse Test at 21°C (70°F)

Bkgnd Drain: Continuous
15K ohms
0.193 mA @2.9V

Pulse Drain: 2 seconds X 12 times/day
400 ohms
6.8 mA @2.7V

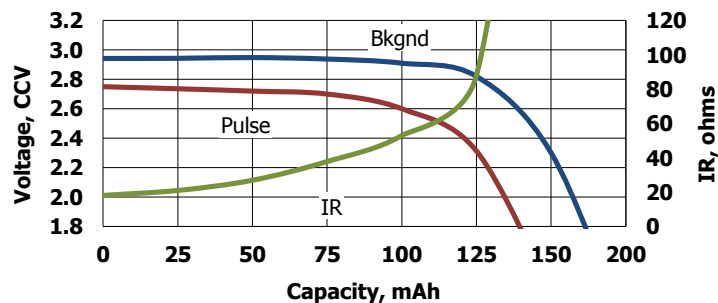

Important Notice

This datasheet contains typical information specific to products manufactured at the time of its publication.
©Energizer Holdings, Inc. - Contents herein do not constitute a warranty.