

EDT2 IGBT and emitter controlled diode in TO247PLUS package

Features

- $V_{CE} = 750\text{ V}$
- $I_C = 120\text{ A}$
- 750 V collector-emitter blocking voltage capability
- Suitable for 470 V V_{DC} systems and increase overvoltage margin for 400 V V_{DC} systems
- Very low $V_{CE(sat)}$, 1.30 V at $I_{Cnom} = 120\text{ A}$, 25°C
- Short circuit robust $t_{sc} = 5\text{ }\mu\text{s}$ at $V_{CE} = 470\text{ V}$, $V_{GE} = 15\text{ V}$
- Self limiting current under short circuit condition
- Positive thermal coefficient and very tight parameter distribution for easy paralleling
- Drop-in replacement for previous generation devices $I_C = 120\text{ A}$, $T_C = 100^\circ\text{C}$
- Excellent current sharing in parallel operation
- Smooth switching characteristics, low EMI signature
- Low gate charge Q_G
- Simple gate drive design
- Co-packed with fast soft recovery emitter controlled 3 diode
- TO247PLUS package with high creepage distance
- High reliability

Potential applications

- xEV traction inverter
- DC-link discharge switch
- Automotive aux-drives

Product validation

- Qualified for automotive applications
- Qualified according to AEC-Q101

Description

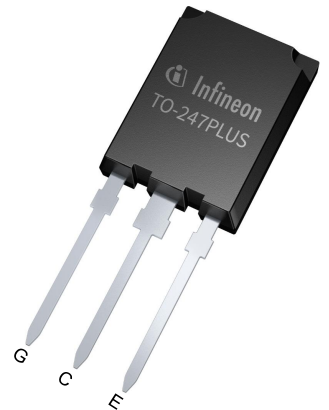
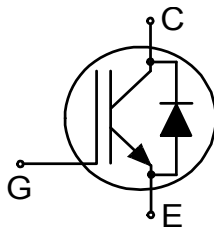

Type	Package	Marking
AIKQ120N75CP2	PG-TO247PLUS-3	AKQ12FCP

Table of contents

	Description	1
	Features	1
	Potential applications	1
	Product validation	1
	Table of contents	2
1	Package	3
2	IGBT	3
3	Diode	5
4	Characteristics diagrams	7
5	Package outlines	14
6	Testing conditions	15
	Revision history	16
	Disclaimer	17

1 Package

Table 1 Characteristic values

Parameter	Symbol	Note or test condition	Values			Unit
			Min.	Typ.	Max.	
Internal emitter inductance measured 5 mm (0.197 in) from case	L_E			13.0		nH
Storage temperature	T_{stg}		-55		150	°C
Soldering temperature		wave soldering 1.6 mm (0.063 in.) from case for 10 s			260	°C
Thermal resistance, junction-ambient	$R_{th(j-a)}$				40	K/W

2 IGBT

Table 2 Maximum rated values

Parameter	Symbol	Note or test condition	Values	Unit
Collector-emitter voltage	V_{CE}		750	V
DC collector current, limited by T_{vjmax}	I_C	$T_c = 25\text{ °C}$	150	A
		$T_c = 100\text{ °C}$	120	
Pulsed collector current, t_p limited by T_{vjmax}	I_{Cpulse}		360	A
Turn-off safe operating area		$V_{CE} \leq 750\text{ V}$, $t_p = 1\text{ }\mu\text{s}$, $T_{vj} \leq 175\text{ °C}$	360	A
Gate-emitter voltage	V_{GE}		± 20	V
Transient gate-emitter voltage	V_{GE}	$t_p < 0.1\text{ }\mu\text{s}$, $D < 0.01$	± 30	V
Short-circuit withstand time	t_{SC}	$V_{CC} \leq 470\text{ V}$, $V_{GE} = 15\text{ V}$, Allowed number of short circuits < 1000 , Time between short circuits $\geq 1.0\text{ s}$, $T_{vj} = 25\text{ °C}$	5	μs
Power dissipation	P_{tot}	$T_c = 25\text{ °C}$	682	W
		$T_c = 100\text{ °C}$	341	

Table 3 Characteristic values

Parameter	Symbol	Note or test condition	Values			Unit	
			Min.	Typ.	Max.		
Collector-emitter saturation voltage	V_{CEsat}	$I_C = 120\text{ A}$, $V_{GE} = 15\text{ V}$	$T_{vj} = 25\text{ °C}$		1.3	1.5	V
			$T_{vj} = 175\text{ °C}$		1.53		
Gate-emitter threshold voltage	V_{GEth}	$I_C = 1.60\text{ mA}$, $V_{CE} = V_{GE}$, $T_{vj} = 25\text{ °C}$	5	5.8	6.5	V	

(table continues...)

Table 3 (continued) Characteristic values

Parameter	Symbol	Note or test condition		Values			Unit
				Min.	Typ.	Max.	
Zero gate-voltage collector current	I_{CES}	$V_{CE} = 750 \text{ V}, V_{GE} = 0 \text{ V}$	$T_{vj} = 25 \text{ }^\circ\text{C}$			200	μA
			$T_{vj} = 175 \text{ }^\circ\text{C}$		4000		
Gate-emitter leakage current	I_{GES}	$V_{CE} = 0 \text{ V}, V_{GE} = 20 \text{ V}$				100	nA
Transconductance	g_{fs}	$I_C = 120 \text{ A}, V_{CE} = 20 \text{ V}$			90		S
Short-circuit collector current	I_{SC}	$V_{CC} \leq 470 \text{ V}, V_{GE} = 15 \text{ V}, t_{SC} \leq 5 \mu\text{s}$, Allowed number of short circuits < 1000 , Time between short circuits $\geq 1.0 \text{ s}$, $T_{vj} = 25 \text{ }^\circ\text{C}$			750		A
Input capacitance	C_{ies}	$V_{CE} = 25 \text{ V}, V_{GE} = 0 \text{ V}, f = 100 \text{ kHz}$			13125		pF
Output capacitance	C_{oes}	$V_{CE} = 25 \text{ V}, V_{GE} = 0 \text{ V}, f = 100 \text{ kHz}$			337		pF
Reverse transfer capacitance	C_{res}	$V_{CE} = 25 \text{ V}, V_{GE} = 0 \text{ V}, f = 100 \text{ kHz}$			59		pF
Gate charge	Q_G	$I_C = 120 \text{ A}, V_{GE} = 15 \text{ V}, V_{CE} = 600 \text{ V}$			731		nC
Turn-on delay time	t_{don}	$V_{CE} = 470 \text{ V}, V_{GE} = -8/15 \text{ V}, R_{Gon} = 5.0 \Omega, R_{Goff} = 5.0 \Omega, L_\sigma = 50 \text{ nH}, C_\sigma = 30 \text{ pF}$	$T_{vj} = 25 \text{ }^\circ\text{C}, I_C = 120 \text{ A}$			71	ns
			$T_{vj} = 175 \text{ }^\circ\text{C}, I_C = 120 \text{ A}$			50	
Rise time (inductive load)	t_r	$V_{CE} = 470 \text{ V}, V_{GE} = -8/15 \text{ V}, R_{Gon} = 5.0 \Omega, R_{Goff} = 5.0 \Omega, L_\sigma = 50 \text{ nH}, C_\sigma = 30 \text{ pF}$	$T_{vj} = 25 \text{ }^\circ\text{C}, I_C = 120 \text{ A}$			69	ns
			$T_{vj} = 175 \text{ }^\circ\text{C}, I_C = 120 \text{ A}$			68	
Turn-off delay time	t_{doff}	$V_{CE} = 470 \text{ V}, V_{GE} = -8/15 \text{ V}, R_{Gon} = 5.0 \Omega, R_{Goff} = 5.0 \Omega, L_\sigma = 50 \text{ nH}, C_\sigma = 30 \text{ pF}$	$T_{vj} = 25 \text{ }^\circ\text{C}, I_C = 120 \text{ A}$			244	ns
			$T_{vj} = 175 \text{ }^\circ\text{C}, I_C = 120 \text{ A}$			226	
Fall time (inductive load)	t_f	$V_{CE} = 470 \text{ V}, V_{GE} = -8/15 \text{ V}, R_{Gon} = 5.0 \Omega, R_{Goff} = 5.0 \Omega, L_\sigma = 50 \text{ nH}, C_\sigma = 30 \text{ pF}$	$T_{vj} = 25 \text{ }^\circ\text{C}, I_C = 120 \text{ A}$			50.5	ns
			$T_{vj} = 175 \text{ }^\circ\text{C}, I_C = 120 \text{ A}$			67	
Turn-on energy ¹⁾	E_{on}	$V_{CE} = 470 \text{ V}, V_{GE} = -8/15 \text{ V}, R_{Gon} = 5.0 \Omega, R_{Goff} = 5.0 \Omega, L_\sigma = 50 \text{ nH}, C_\sigma = 30 \text{ pF}$	$T_{vj} = 25 \text{ }^\circ\text{C}, I_C = 120 \text{ A}$			6.82	mJ
			$T_{vj} = 175 \text{ }^\circ\text{C}, I_C = 120 \text{ A}$			7.3	
Turn-off energy	E_{off}	$V_{CE} = 470 \text{ V}, V_{GE} = -8/15 \text{ V}, R_{Gon} = 5.0 \Omega, R_{Goff} = 5.0 \Omega, L_\sigma = 50 \text{ nH}, C_\sigma = 30 \text{ pF}$	$T_{vj} = 25 \text{ }^\circ\text{C}, I_C = 120 \text{ A}$			3.8	mJ
			$T_{vj} = 175 \text{ }^\circ\text{C}, I_C = 120 \text{ A}$			4.7	

(table continues...)

Table 3 (continued) Characteristic values

Parameter	Symbol	Note or test condition	Values			Unit	
			Min.	Typ.	Max.		
Total switching energy	E_{ts}	$V_{CE} = 470 \text{ V}, V_{GE} = -8/15 \text{ V}, R_{Gon} = 5.0 \text{ } \Omega, R_{Goff} = 5.0 \text{ } \Omega, L_{\sigma} = 50 \text{ nH}, C_{\sigma} = 30 \text{ pF}$	$T_{vj} = 25 \text{ } ^\circ\text{C}, I_C = 120 \text{ A}$		10.3		mJ
			$T_{vj} = 175 \text{ } ^\circ\text{C}, I_C = 120 \text{ A}$		12.1		
IGBT thermal resistance, junction to case ²⁾	R_{thjc}				0.22	K/W	
Operating junction temperature	T_{vj}		-40		175	$^\circ\text{C}$	

1) Includes reverse recovery losses

2) Not subject to production test - specified by simulation.

3 Diode

Table 4 Maximum rated values

Parameter	Symbol	Note or test condition	Values	Unit	
Diode forward current, limited by T_{vjmax}	I_F		$T_c = 25 \text{ } ^\circ\text{C}$	150	A
			$T_c = 100 \text{ } ^\circ\text{C}$	120	
Diode pulsed current, limited by T_{vjmax}	I_{Fpulse}		360	A	
Power dissipation	P_{tot}		$T_c = 25 \text{ } ^\circ\text{C}$	375	W
			$T_c = 100 \text{ } ^\circ\text{C}$	170	

Table 5 Characteristic values

Parameter	Symbol	Note or test condition	Values			Unit	
			Min.	Typ.	Max.		
Diode forward voltage	V_F	$I_F = 120 \text{ A}$	$T_{vj} = 25 \text{ } ^\circ\text{C}$		1.7	1.95	V
			$T_{vj} = 175 \text{ } ^\circ\text{C}$		1.6		
Diode reverse recovery charge	Q_{rr}	$V_R < 470 \text{ V}, R_{Gon} = 4.8 \text{ } \Omega$	$T_{vj} = 25 \text{ } ^\circ\text{C}, I_F = 120 \text{ A}, -di_F/dt = 1070 \text{ A}/\mu\text{s}$		3.580		μC
			$T_{vj} = 175 \text{ } ^\circ\text{C}, I_F = 120 \text{ A}, -di_F/dt = 1055 \text{ A}/\mu\text{s}$		5.280		

(table continues...)

Table 5 (continued) Characteristic values

Parameter	Symbol	Note or test condition		Values			Unit
				Min.	Typ.	Max.	
Diode peak reverse recovery current	I_{rrm}	$V_R < 470 \text{ V}$, $R_{Gon} = 4.8 \text{ } \Omega$	$T_{vj} = 25 \text{ } ^\circ\text{C}$, $I_F = 120 \text{ A}$, $-di_F/dt = 1070 \text{ A}/\mu\text{s}$		33.0		A
			$T_{vj} = 175 \text{ } ^\circ\text{C}$, $I_F = 120 \text{ A}$, $-di_F/dt = 1055 \text{ A}/\mu\text{s}$		43.0		
Reverse recovery energy	E_{rec}	$V_R < 470 \text{ V}$, $V_{GE} = -8/15 \text{ V}$, $R_{Gon} = 4.8 \text{ } \Omega$, $L_\sigma = 50 \text{ nH}$, $C_\sigma = 30 \text{ pF}$	$I_F = 120 \text{ A}$, $-di_F/dt = 1070 \text{ A}/\mu\text{s}$, $T_{vj} = 25 \text{ } ^\circ\text{C}$		1.24		mJ
			$I_F = 120 \text{ A}$, $-di_F/dt = 1055 \text{ A}/\mu\text{s}$, $T_{vj} = 175 \text{ } ^\circ\text{C}$		1.61		
Diode thermal resistance, junction to case ¹⁾	R_{thjc}					0.4	K/W
Operating junction temperature	T_{vj}			-40		175	$^\circ\text{C}$

¹⁾ Note subject to test

4 Characteristics diagrams

Power dissipation as a function of case temperature, IGBT

$P_{tot} = f(T_c)$
 $T_{vj} \leq 175\text{ }^\circ\text{C}$

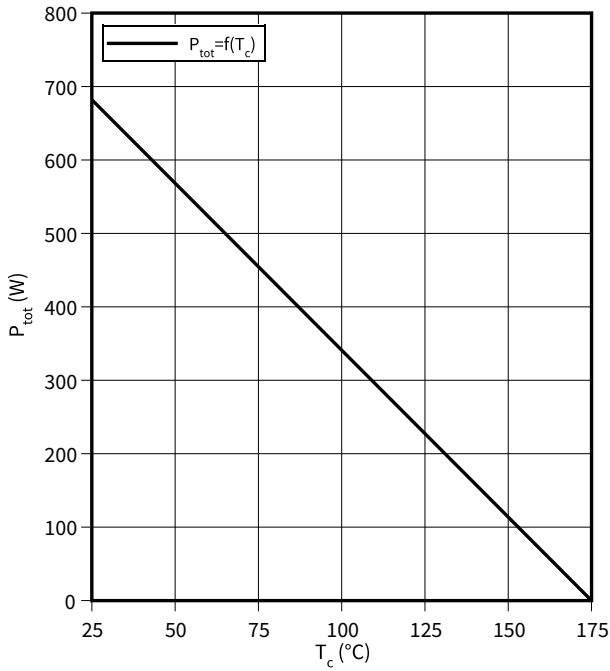

Collector current as a function of case temperature, IGBT

$I_C = f(T_c)$
 $T_{vj} \leq 175\text{ }^\circ\text{C}, V_{GE} = 15\text{ V}$

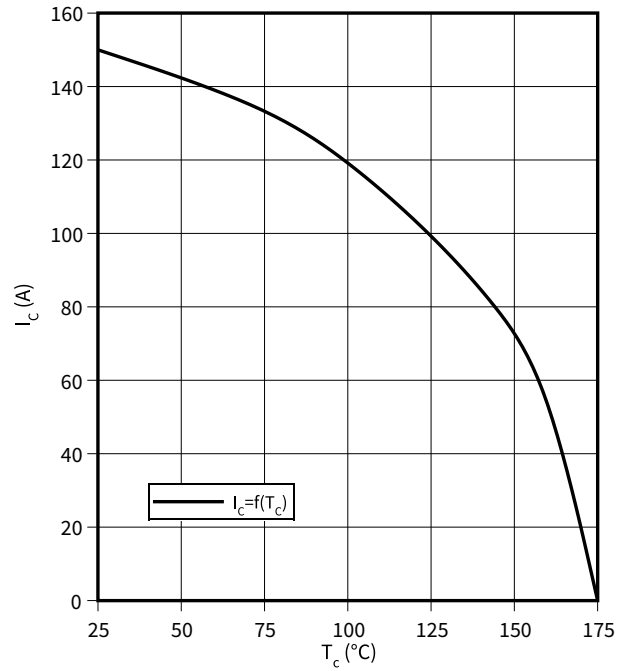

Typical output characteristic, IGBT

$I_C = f(V_{CE})$
 $T_{vj} = 25\text{ }^\circ\text{C}$

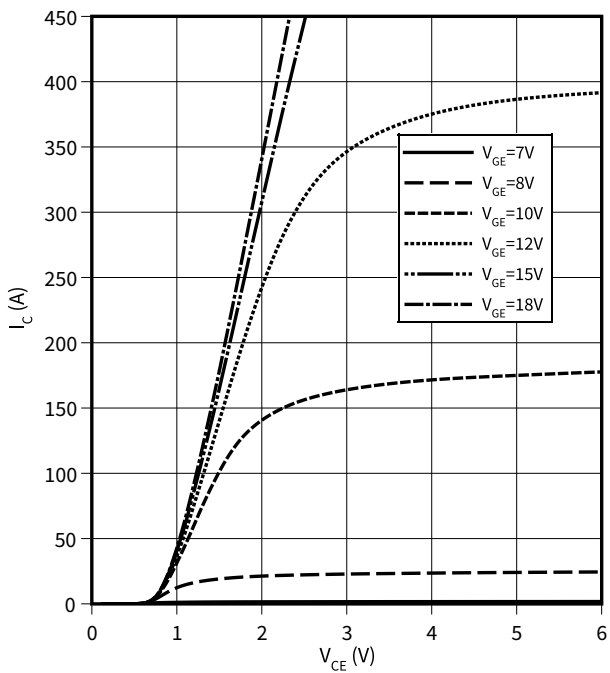

Typical output characteristic, IGBT

$I_C = f(V_{CE})$
 $T_{vj} = 175\text{ }^\circ\text{C}$

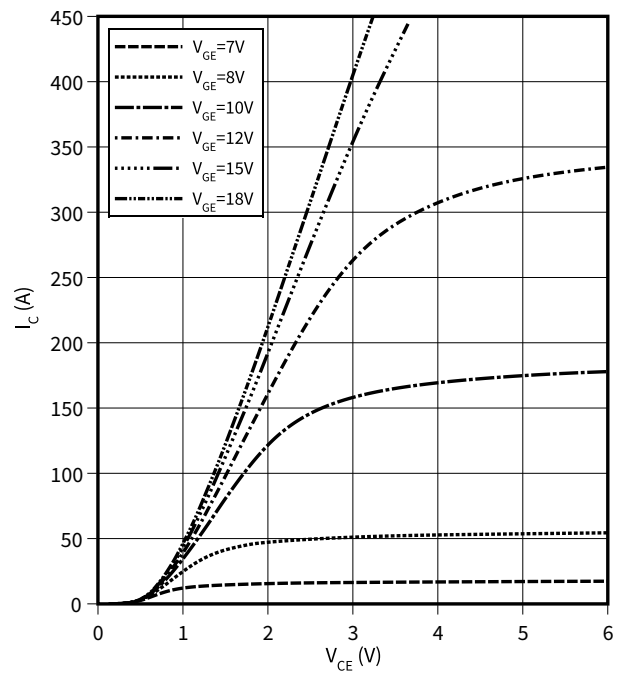

4 Characteristics diagrams

Typical transfer characteristic, IGBT

$I_C = f(V_{GE})$

$V_{CE} = 20\text{ V}$

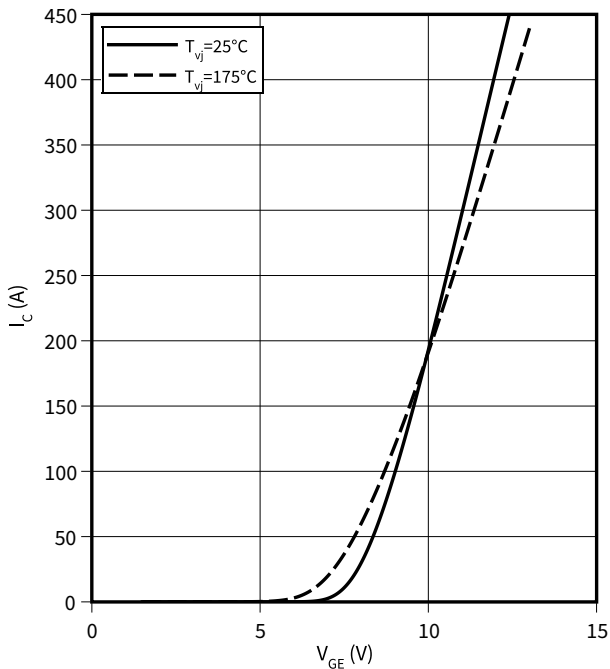

Typical collector-emitter saturation voltage as a function of junction temperature, IGBT

$V_{CEsat} = f(T_{vj})$

$V_{GE} = 15\text{ V}$

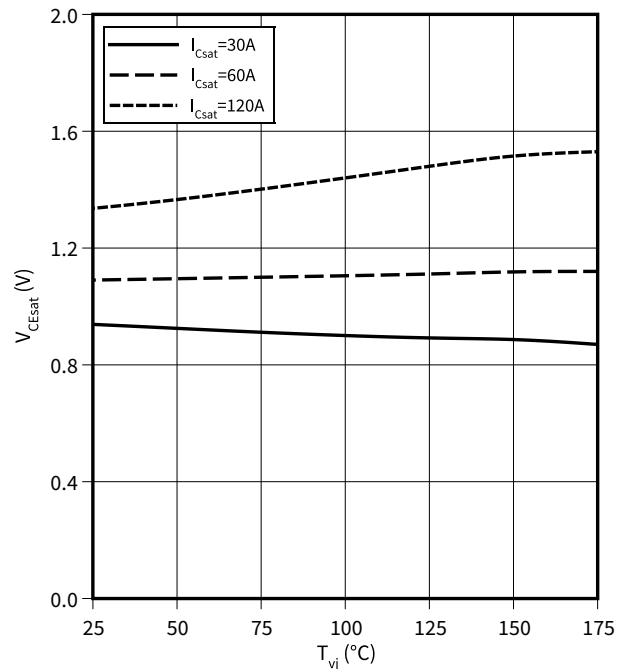

Typical switching times as a function of collector current, IGBT

$t = f(I_C)$

$R_{Goff} = 5.0\ \Omega, V_{CE} = 470\text{ V}, T_{vj} = 175\text{ °C}, V_{GE} = -8/15\text{ V}, R_{Gon} = 5.0\ \Omega$

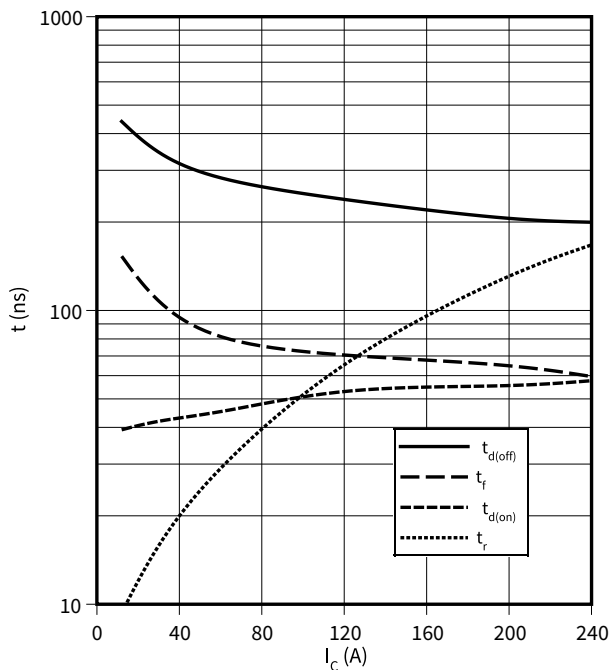

Typical switching times as a function of gate resistor, IGBT

$t = f(R_G)$

$I_C = 120.0\text{ A}, V_{CE} = 470\text{ V}, T_{vj} = 175\text{ °C}, V_{GE} = -8/15\text{ V}$

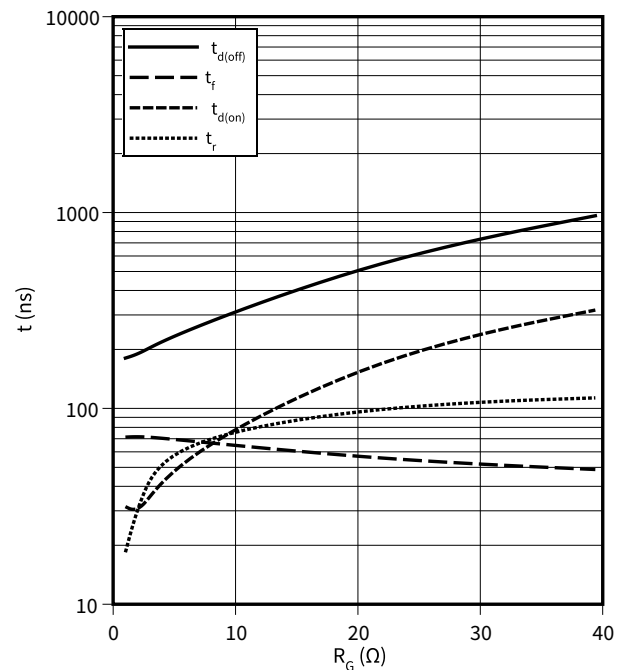

Typical switching times as a function of junction temperature, IGBT

$t = f(T_{vj})$

$I_C = 120.0 \text{ A}$, $R_{Goff} = 5.0 \text{ } \Omega$, $V_{CE} = 470 \text{ V}$, $V_{GE} = -8/15 \text{ V}$, $R_{Gon} = 5.0 \text{ } \Omega$

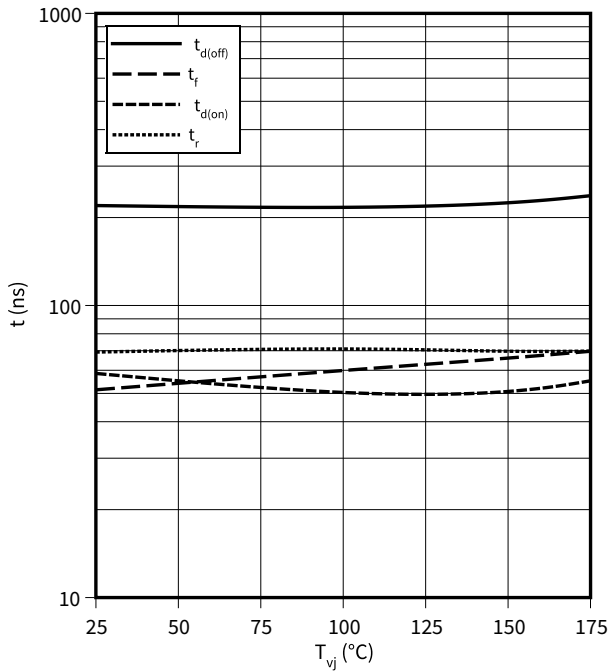

Typical Gate-emitter threshold voltage as a function of junction temperature, IGBT

$V_{GEth} = f(T_{vj})$

$I_C = 1.60 \text{ mA}$

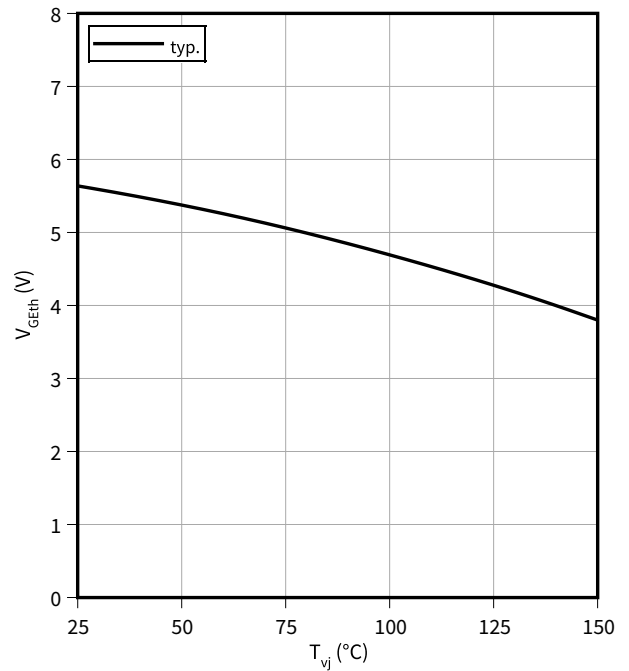

Typical switching energy losses as a function of gate resistor, IGBT

$E = f(R_G)$

$I_C = 120.0 \text{ A}$, $V_{CE} = 470 \text{ V}$, $T_{vj} = 175 \text{ } ^\circ\text{C}$, $V_{GE} = -8/15 \text{ V}$

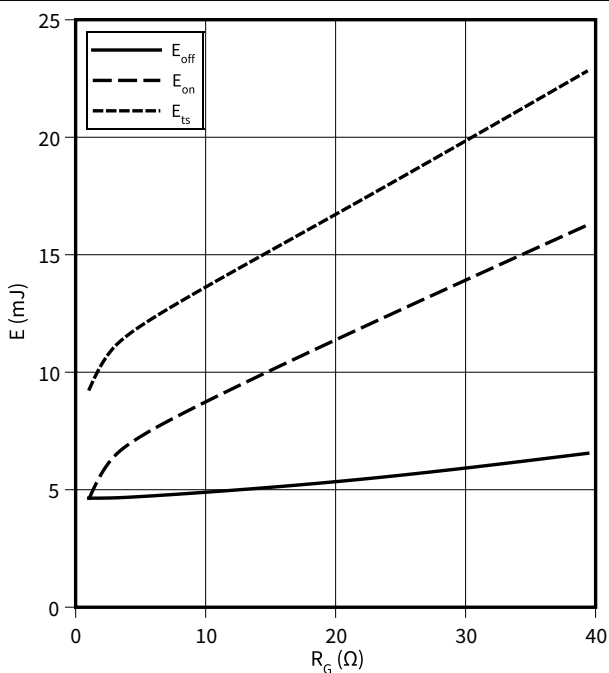

Typical switching energy losses as a function of collector current, IGBT

$E = f(I_C)$

$R_{Goff} = 5.0 \text{ } \Omega$, $V_{CE} = 470 \text{ V}$, $T_{vj} = 175 \text{ } ^\circ\text{C}$, $V_{GE} = -8/15 \text{ V}$, $R_{Gon} = 5.0 \text{ } \Omega$

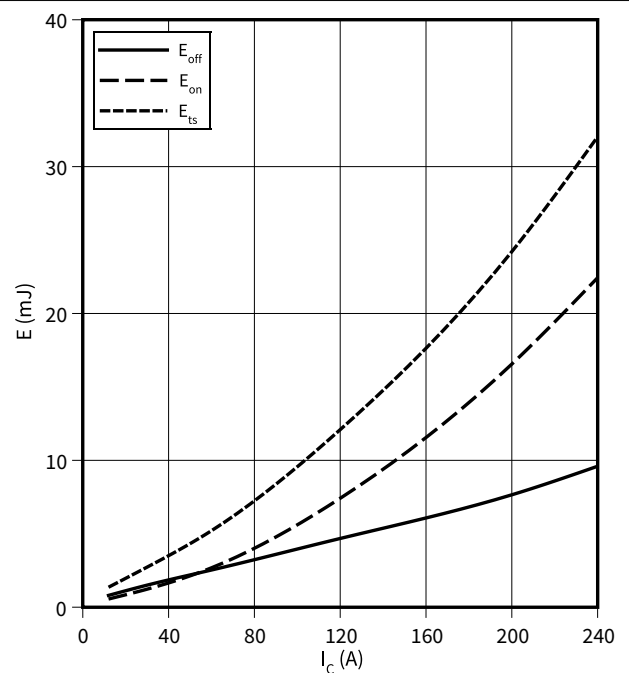

4 Characteristics diagrams

Typical switching energy losses as a function of junction temperature, IGBT

$E = f(T_{vj})$

$I_C = 120.0 \text{ A}$, $R_{Goff} = 5.0 \ \Omega$, $V_{CE} = 470 \text{ V}$, $V_{GE} = -8/15 \text{ V}$, $R_{Gon} = 5.0 \ \Omega$

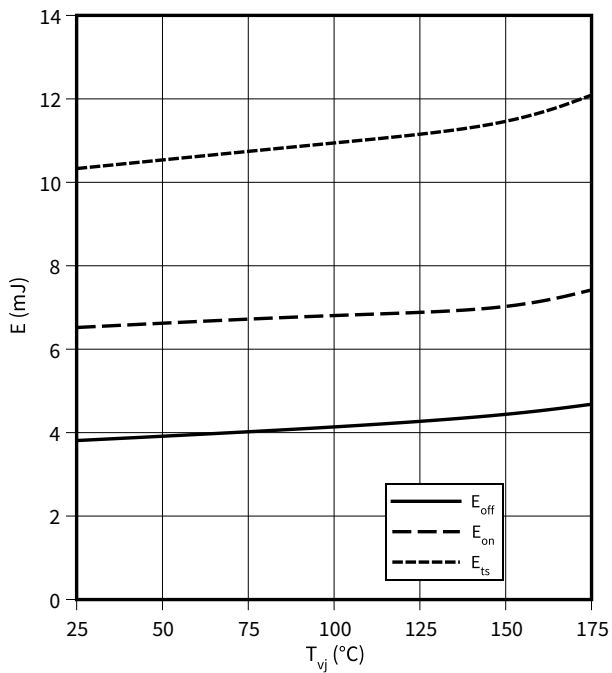

Typical switching energy losses as a function of collector emitter voltage, IGBT

$E = f(V_{CE})$

$I_C = 120 \text{ A}$, $R_{Goff} = 5.0 \ \Omega$, $T_{vj} \leq 175 \text{ °C}$, $V_{GE} = -8/15 \text{ V}$, $R_{Gon} = 5.0 \ \Omega$

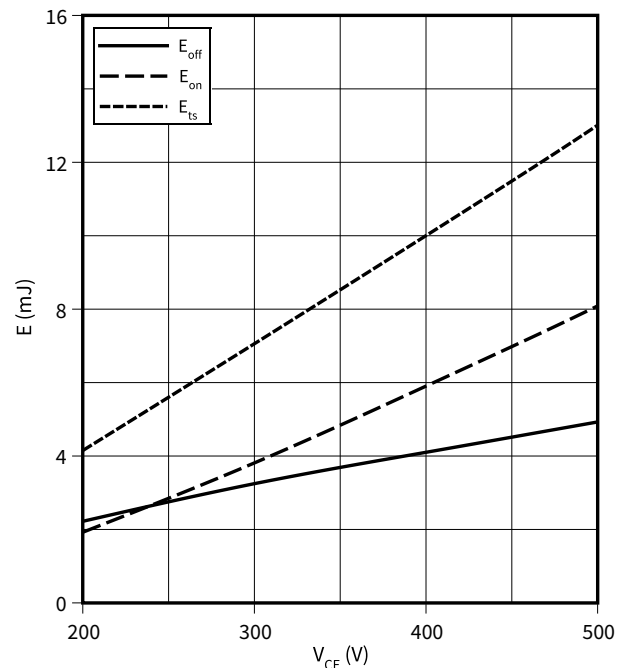

Typical capacitance as a function of collector-emitter voltage, IGBT

$C = f(V_{CE})$

$f = 100 \text{ kHz}$, $V_{GE} = 0 \text{ V}$

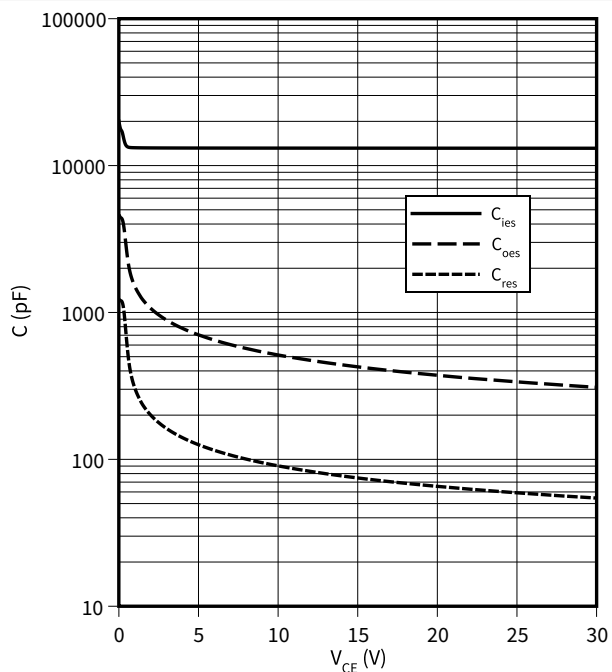

Typical gate charge, IGBT

$V_{GE} = f(Q_{GE})$

$I_C = 120.0 \text{ A}$

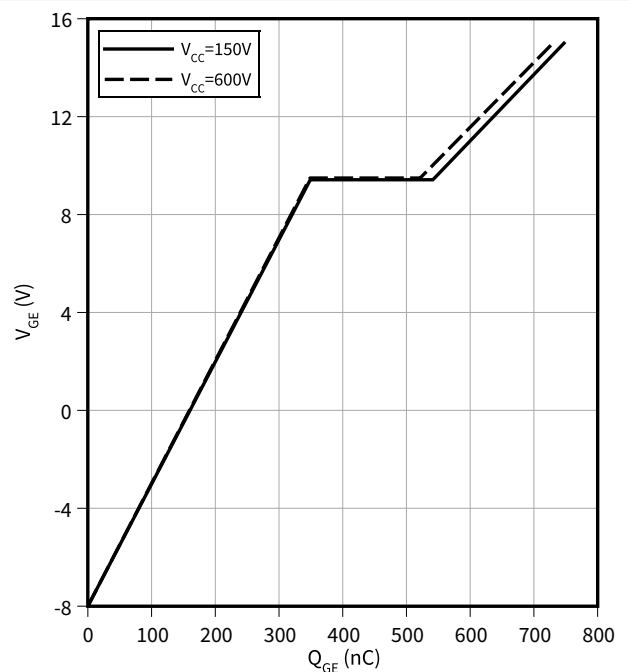

4 Characteristics diagrams

Typical Short circuit withstand time as a function of gate-emitter voltage, IGBT

$t_{SC} = f(V_{GE})$
 $T_{vj} \leq 175\text{ }^\circ\text{C}, V_{CC} \leq 470\text{ V}$

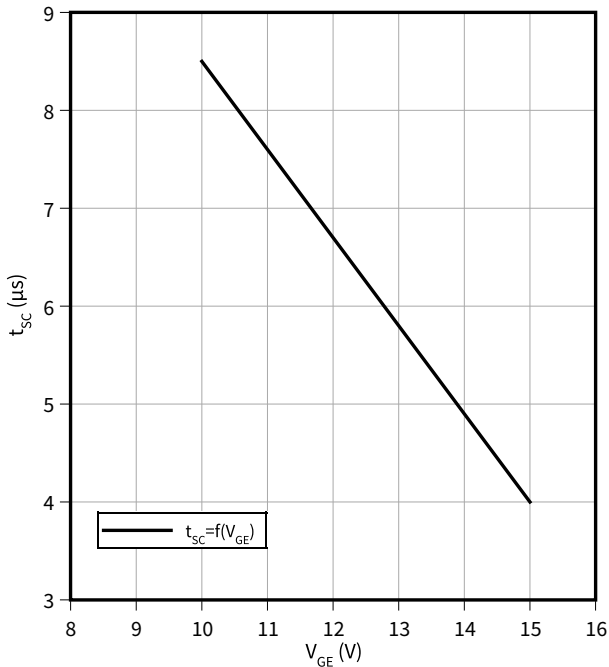

Typical short circuit collector current as a function of gate-emitter voltage, IGBT

$I_{C(SC)} = f(V_{GE})$
 $T_{vj} \leq 175\text{ }^\circ\text{C}, V_{CC} \leq 470\text{ V}$

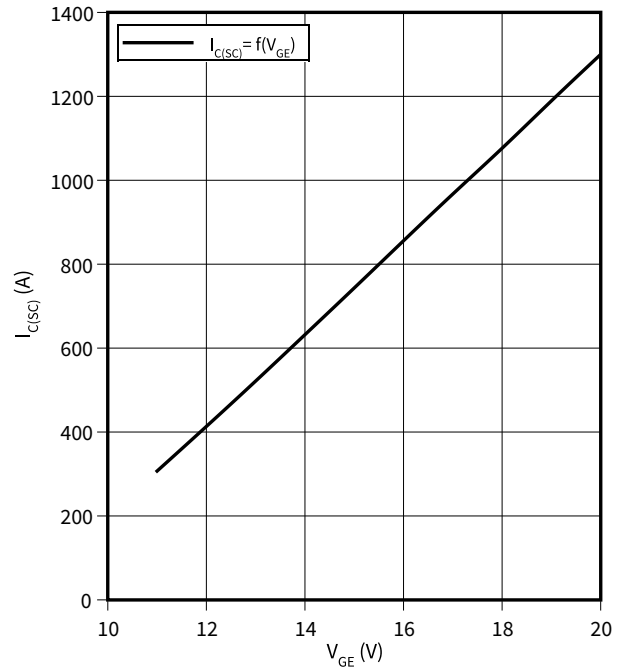

IGBT transient thermal impedance as a function of pulse width, IGBT

$Z_{th} = f(t_p)$
 $D = t_p/T$

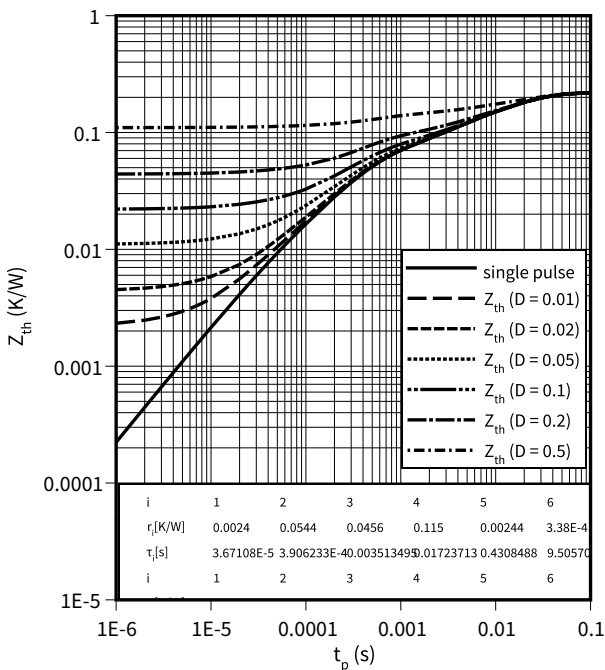

Diode transient thermal impedance as a function of pulse width, Diode

$Z_{th} = f(t_p)$
 $D = t_p/T$

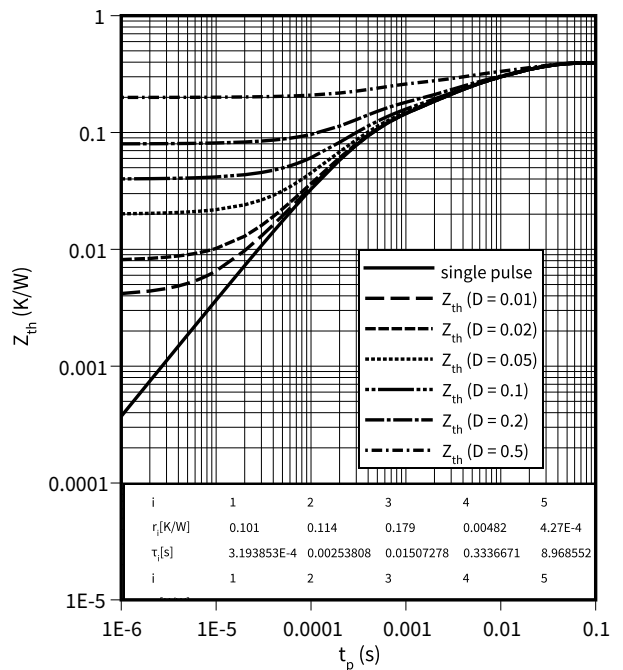

4 Characteristics diagrams

Typical reverse recovery time as a function of diode current slope, Diode

$t_{rr} = f(di_F/dt)$

$V_R = 470 \text{ V}, I_F = 120.0 \text{ A}$

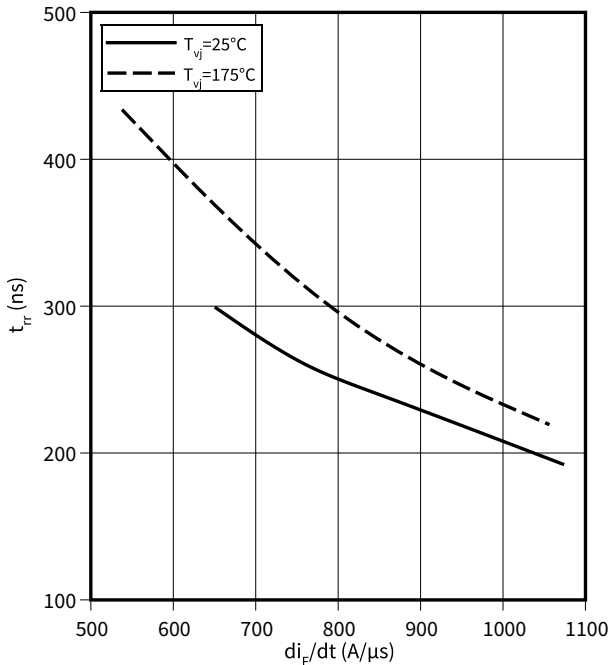

Typical reverse recovery charge as a function of diode current slope, Diode

$Q_{rr} = f(di_F/dt)$

$V_R = 470 \text{ V}, I_F = 120.0 \text{ A}$

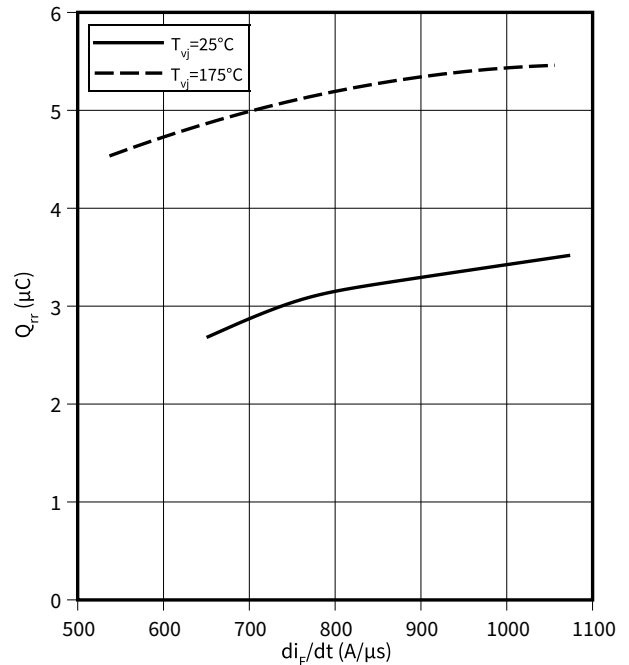

Typical reverse recovery current as a function of diode current slope, Diode

$I_{rr} = f(di_F/dt)$

$V_R = 470 \text{ V}, I_F = 120.0 \text{ A}$

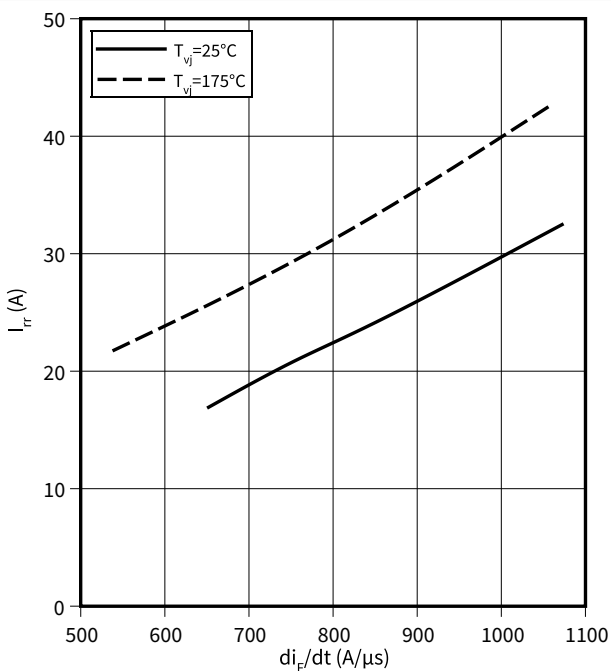

Typical diode peak rate of fall of reverse recovery current as a function of diode current slope, Diode

$di_{rr}/dt = f(di_F/dt)$

$V_R = 470 \text{ V}, I_F = 120.0 \text{ A}$

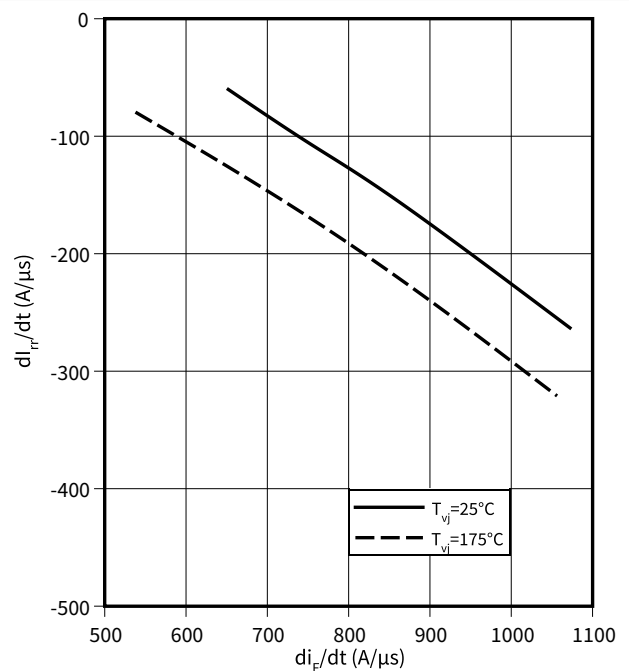

Typical diode forward voltage as a function of junction temperature, Diode

$V_F = f(T_{vj})$

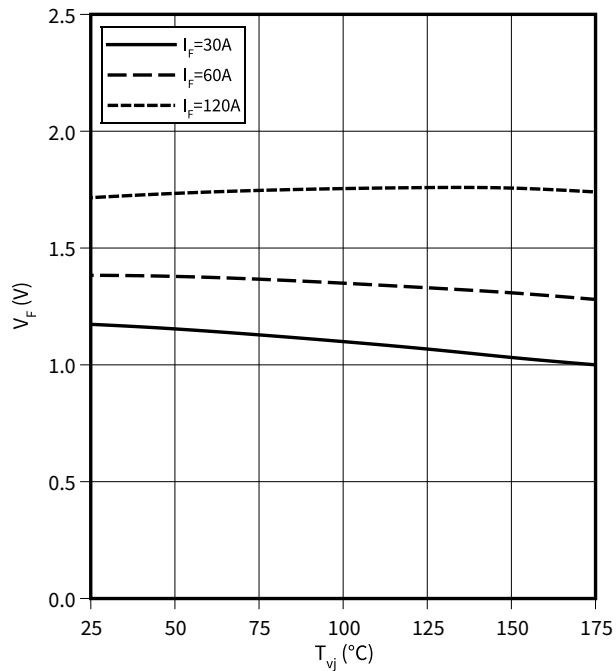

Typical diode forward current as a function of forward voltage, Diode

$I_F = f(V_F)$

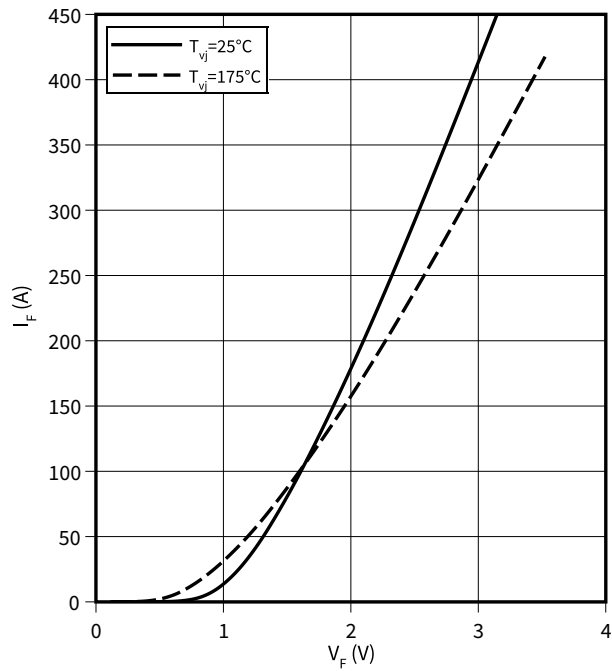

5 Package outlines

Package Drawing PG-TO247PLUS-3

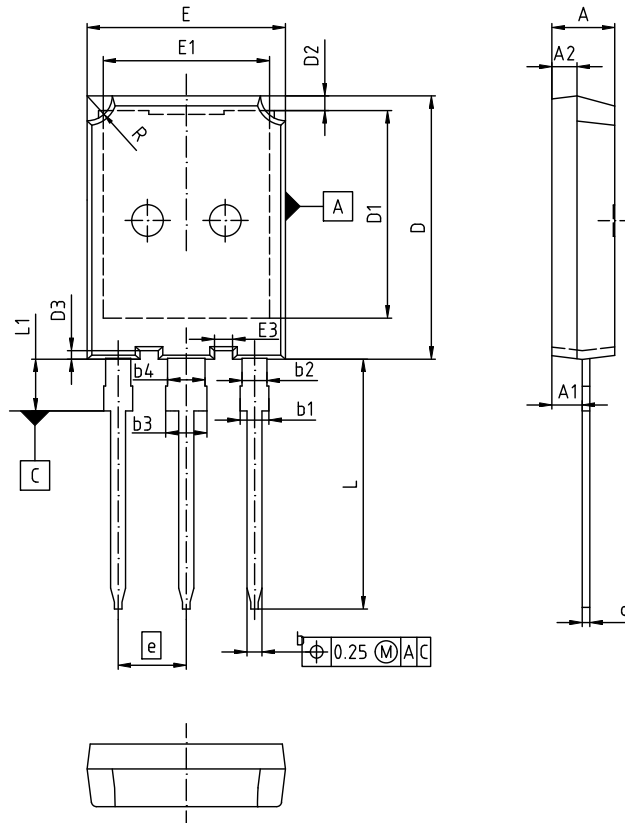

DIM	MILLIMETERS		INCHES	
	MIN	MAX	MIN	MAX
A	4.90	5.10	0.193	0.201
A1	2.31	2.51	0.091	0.099
A2	1.90	2.10	0.075	0.083
b	1.16	1.26	0.046	0.050
b1	1.96	2.25	0.077	0.089
b2	1.96	2.06	0.077	0.081
c	0.59	0.66	0.023	0.026
D	20.90	21.10	0.823	0.831
D1	16.25	16.85	0.640	0.663
D2	1.05	1.35	0.041	0.053
D3	0.58	0.78	0.023	0.031
E	15.70	15.90	0.618	0.626
E1	13.10	13.50	0.516	0.531
E3	1.35	1.55	0.053	0.061
e	5.44 (BSC)		0.214 (BSC)	
N	3		3	
L	19.80	20.10	0.780	0.791
L1	-	4.30	-	0.169
R	1.90	2.10	0.075	0.083

DOCUMENT NO.
Z8B00174295

SCALE

EUROPEAN PROJECTION

ISSUE DATE
13-08-2014

REVISION
01

Figure 1

6 Testing conditions

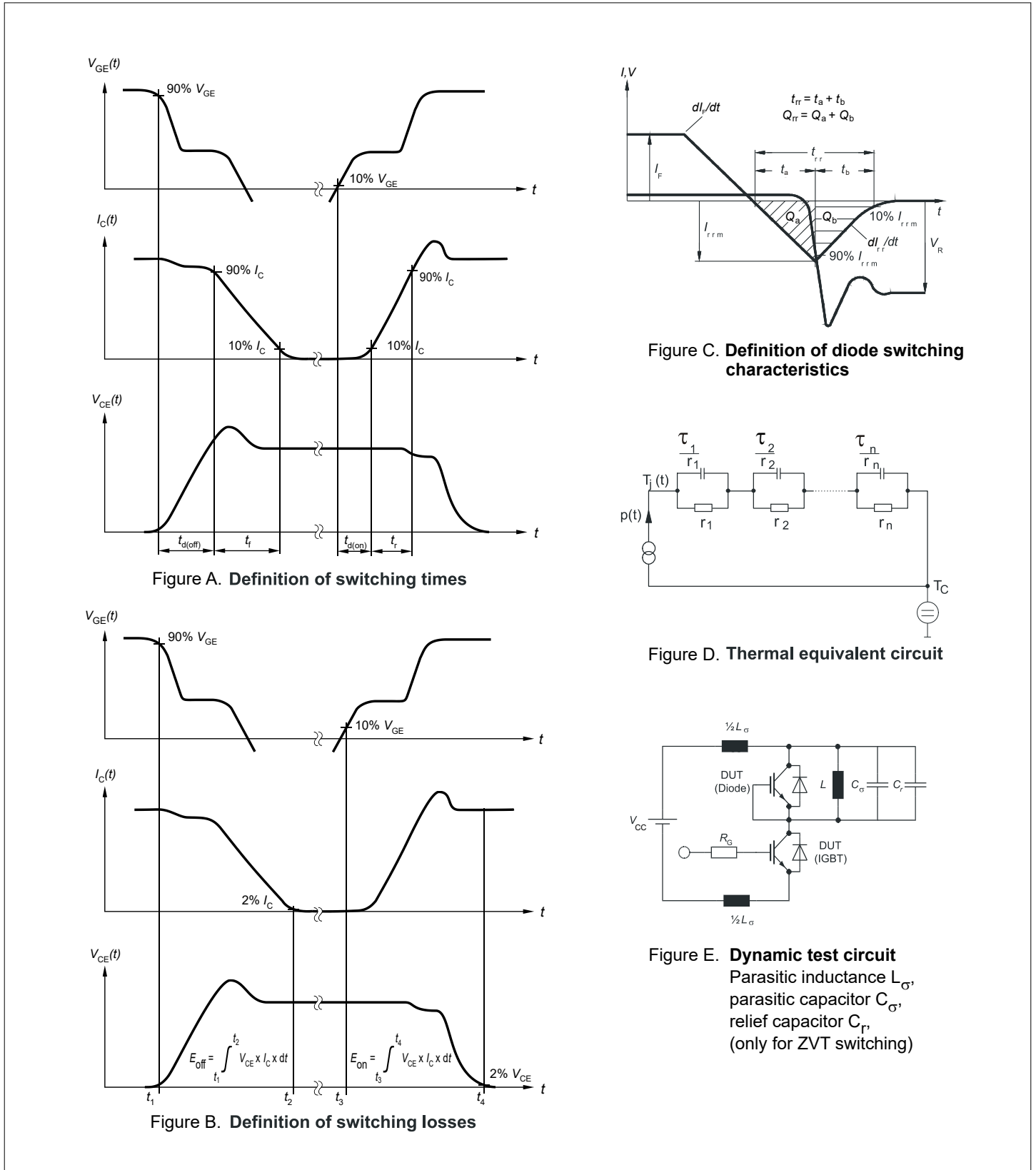

Figure 2

Revision history

Document revision	Date of release	Description of changes
1.00	2022-02-16	Final datasheet

Trademarks

All referenced product or service names and trademarks are the property of their respective owners.

Edition 2022-02-16

Published by

Infineon Technologies AG

81726 Munich, Germany

© 2022 Infineon Technologies AG

All Rights Reserved.

Do you have a question about any aspect of this document?

Email: erratum@infineon.com

Document reference

IFX-ABB226-001

IMPORTANT NOTICE

The information given in this document shall in no event be regarded as a guarantee of conditions or characteristics ("Beschaffenhheitsgarantie").

With respect to any examples, hints or any typical values stated herein and/or any information regarding the application of the product, Infineon Technologies hereby disclaims any and all warranties and liabilities of any kind, including without limitation warranties of non-infringement of intellectual property rights of any third party.

In addition, any information given in this document is subject to customer's compliance with its obligations stated in this document and any applicable legal requirements, norms and standards concerning customer's products and any use of the product of Infineon Technologies in customer's applications.

The data contained in this document is exclusively intended for technically trained staff. It is the responsibility of customer's technical departments to evaluate the suitability of the product for the intended application and the completeness of the product information given in this document with respect to such application.

WARNINGS

Due to technical requirements products may contain dangerous substances. For information on the types in question please contact your nearest Infineon Technologies office.

Except as otherwise explicitly approved by Infineon Technologies in a written document signed by authorized representatives of Infineon Technologies, Infineon Technologies' products may not be used in any applications where a failure of the product or any consequences of the use thereof can reasonably be expected to result in personal injury.