

ENVIRONMENTAL SPECIFICATIONS

Operating Environment (Indoor or Outdoor)	Outdoor
Operating Temperature – °C (°F)	-40 to +85°C (-40 to +185°F)
Storage Temperature – °C (°F)	-40 to +85°C (-40 to +185°F)
Ingress Protection Rating	IP67
Flammability Rating	UL94 V0
Material Substance Compliance	RoHS

CONFIGURATION

PART NUMBER	Operating Frequency	Color
FTRA6171M5PB-001	617 – 7125 MHz	Black
FTRA6171M5PW-001	617 – 7125 MHz	White
FTRA6971M5PB-001	698 – 7125 MHz	Black
FTRA6971M5PW-001	698 – 7125 MHz	White

MECHANICAL DRAWING

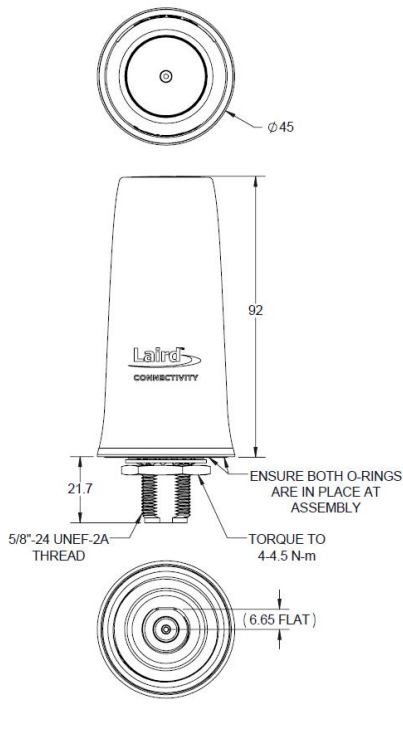

Figure 1: FTRA6171M5Px mechanical drawing

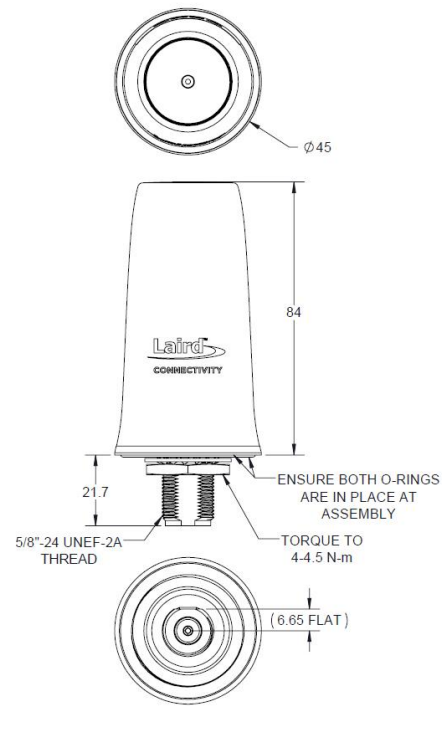
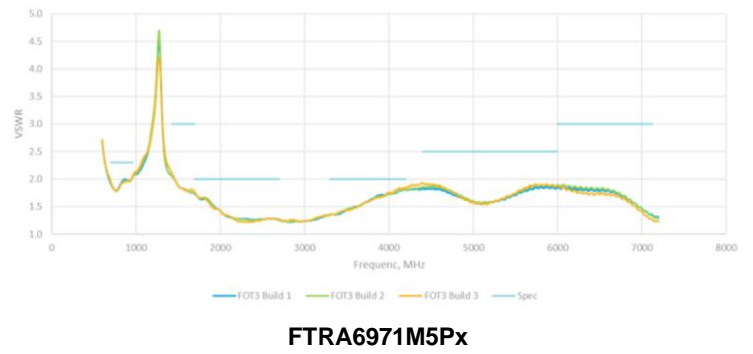
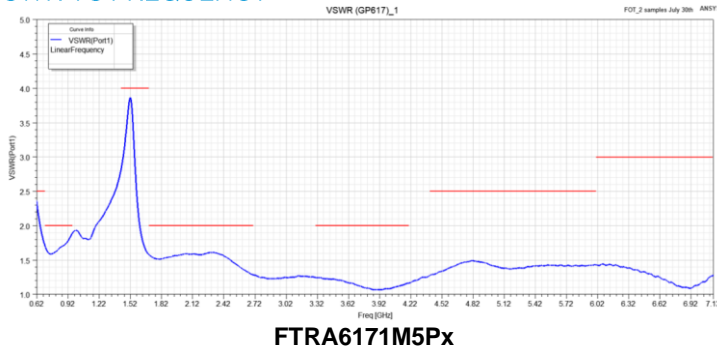
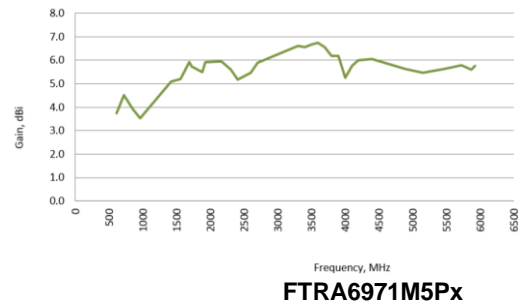
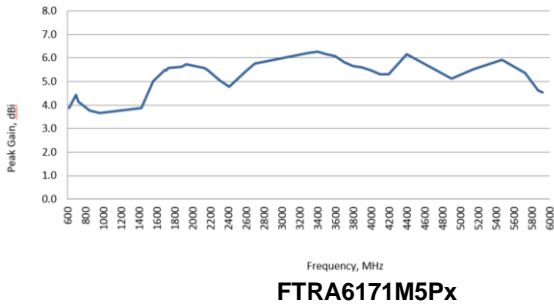

Figure 2: FTRA6971M5Px mechanical drawing

VSWR VS FREQUENCY



PEAK GAIN VS FREQUENCY



RADIATED EFFICIENCY VS FREQUENCY

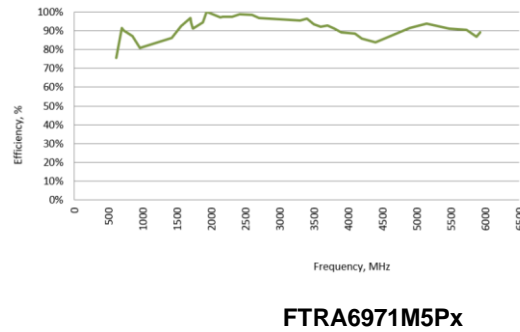
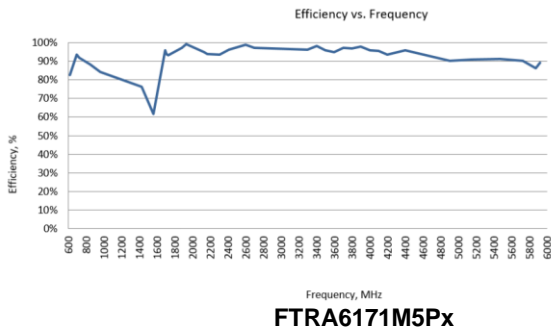

GAIN RIPPLE VS FREQUENCY

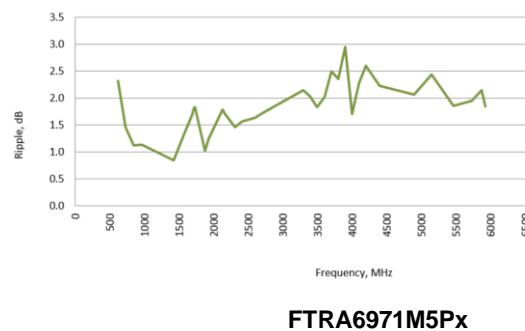
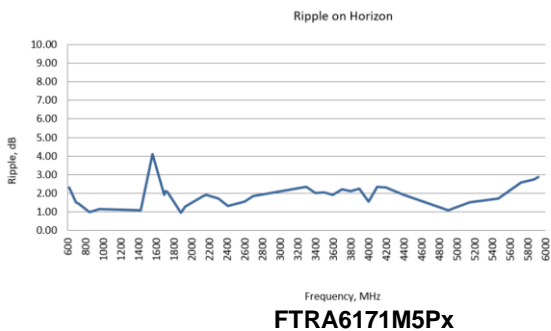

RADIATION PATTERNS

617 MHz (FTRA6171M5Px)

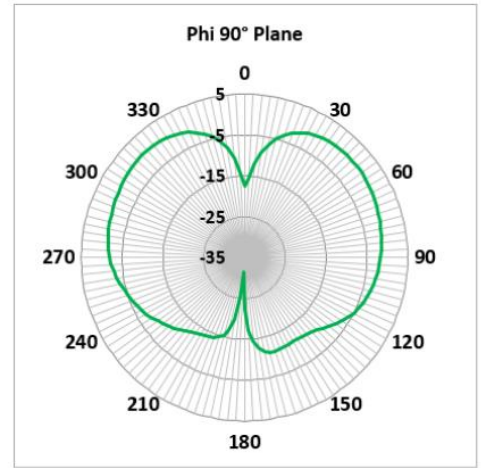
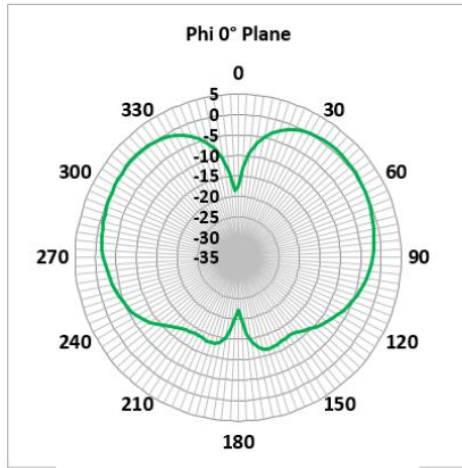
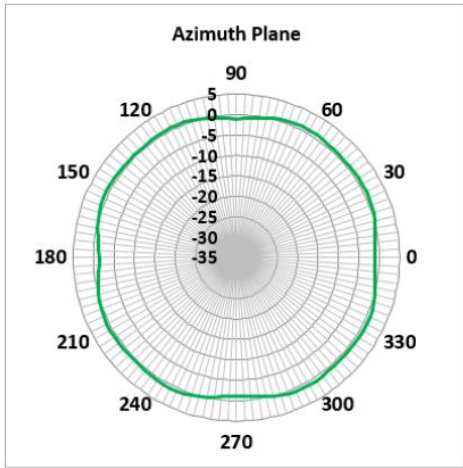

698 MHz (FTRA6171M5Px)

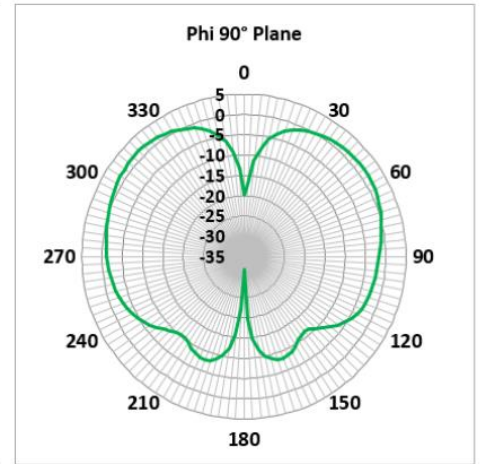
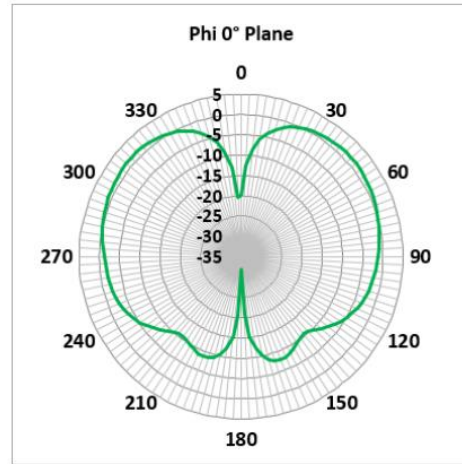
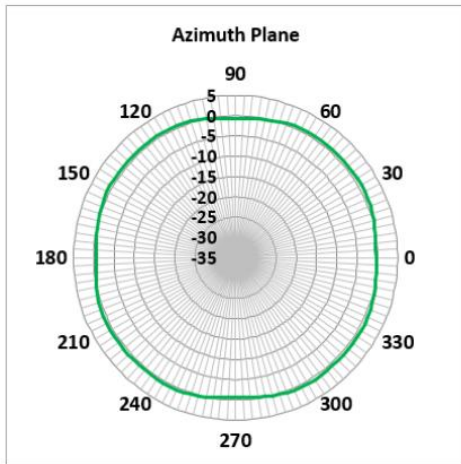

960 MHz (FTRA6171M5Px)

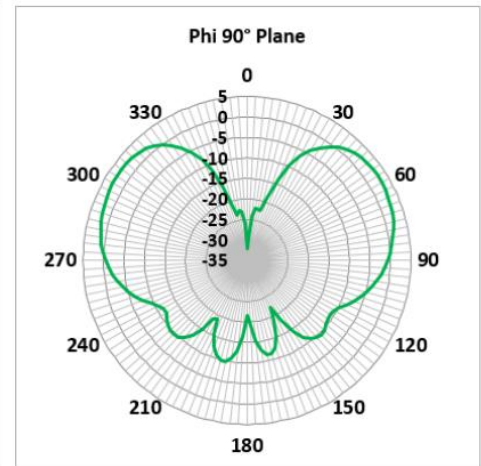
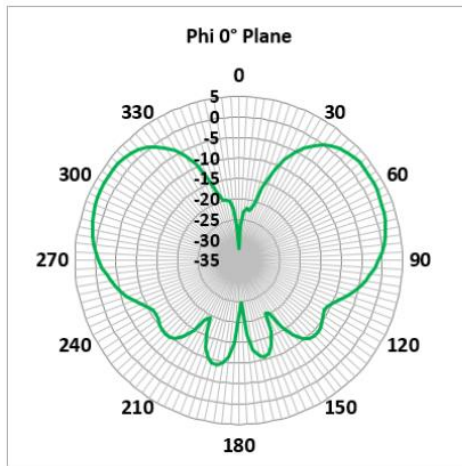
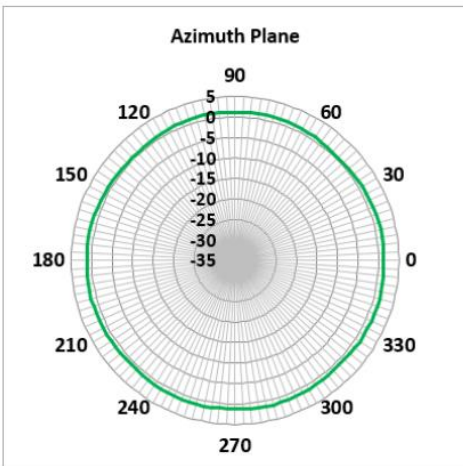

RADIATION PATTERNS (CONTINUED)

1427 MHz (FTRA6171M5Px)

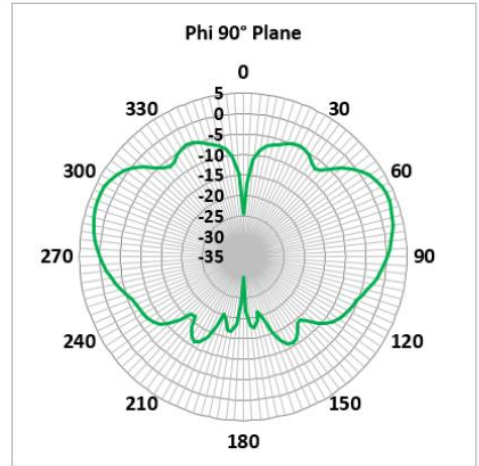
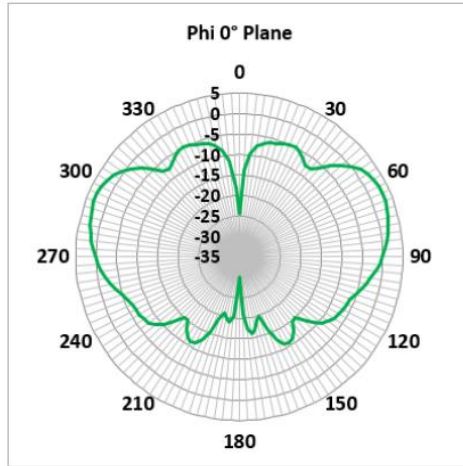
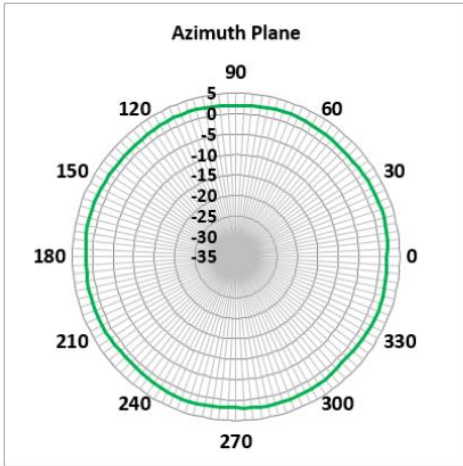

1695 MHz (FTRA6171M5Px)

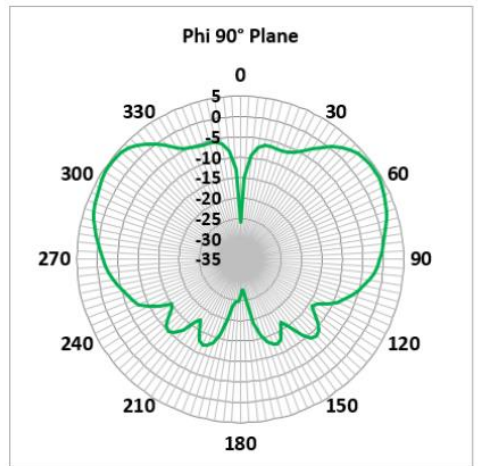
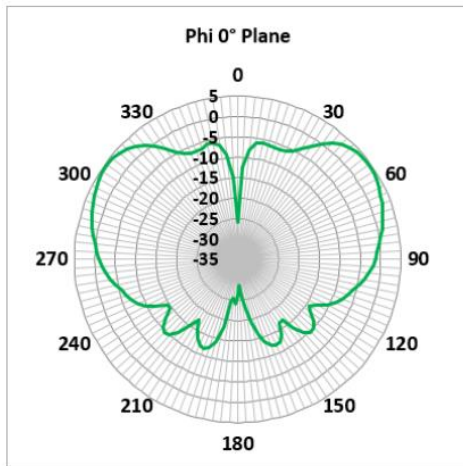
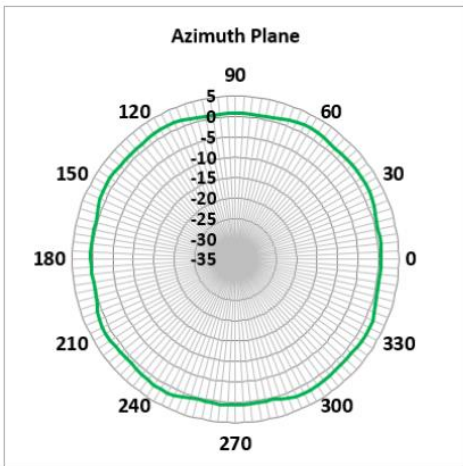

2170 MHz (FTRA6171M5Px)

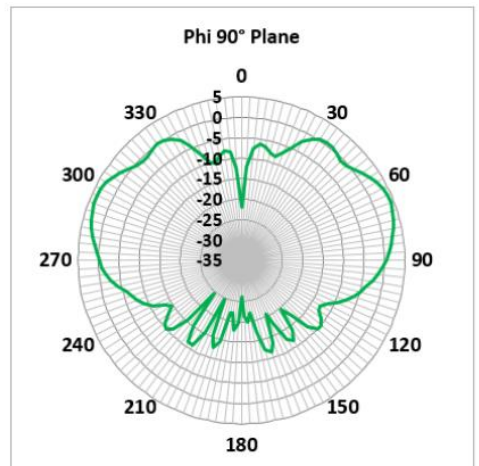
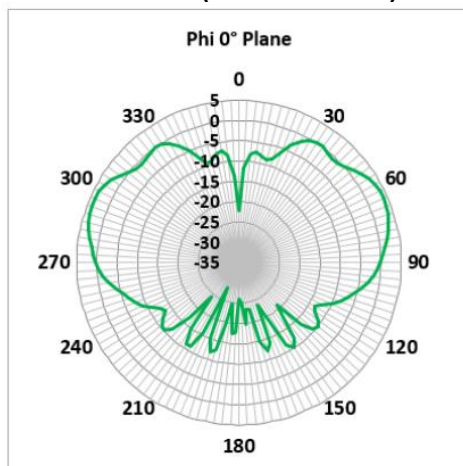
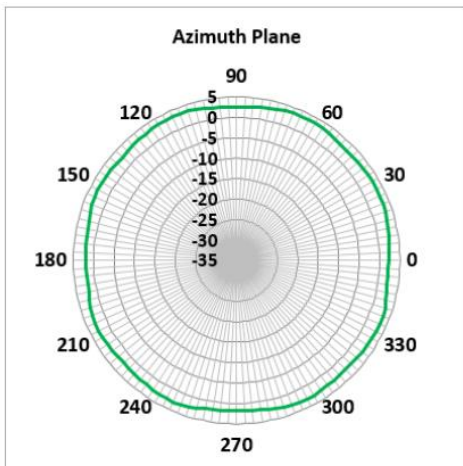

RADIATION PATTERNS (CONTINUED)

2310 MHz (FTRA6171M5Px)

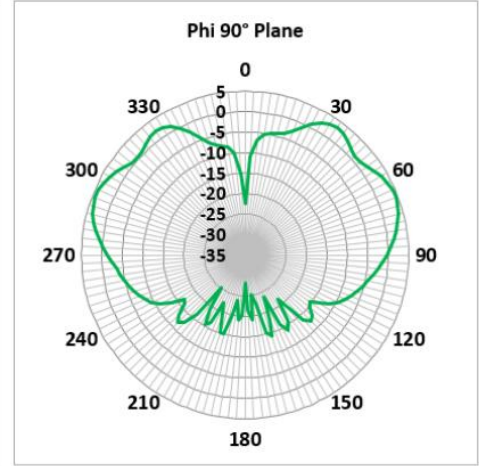
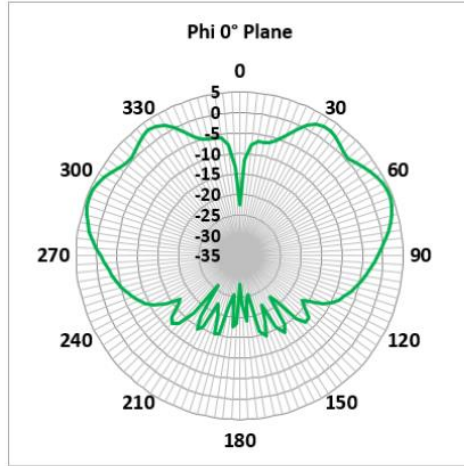
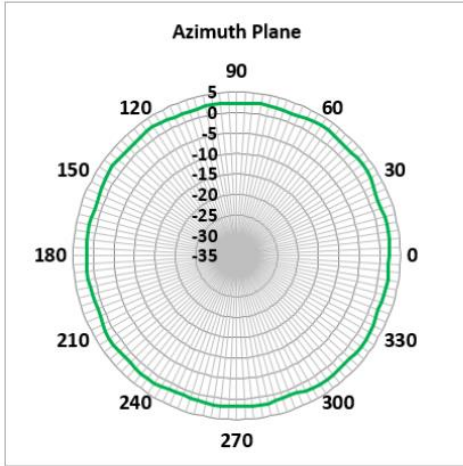

2700 MHz (FTRA6171M5Px)

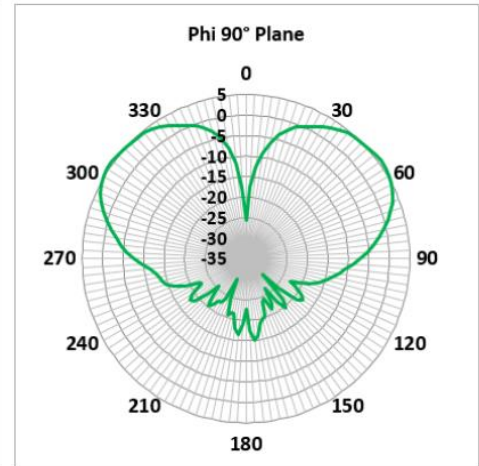
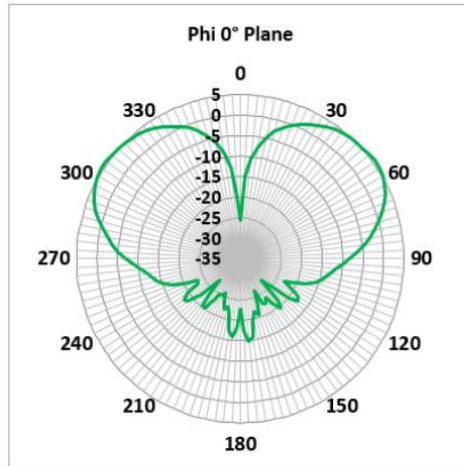
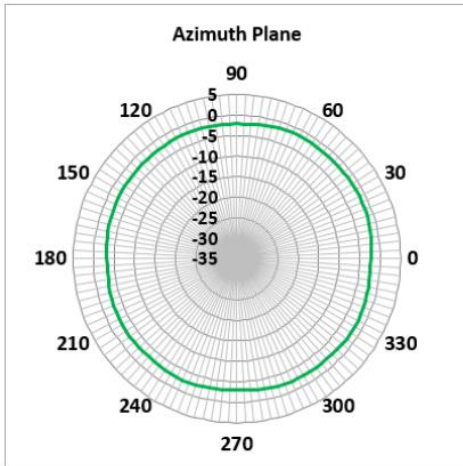

3300 MHz (FTRA6171M5Px)

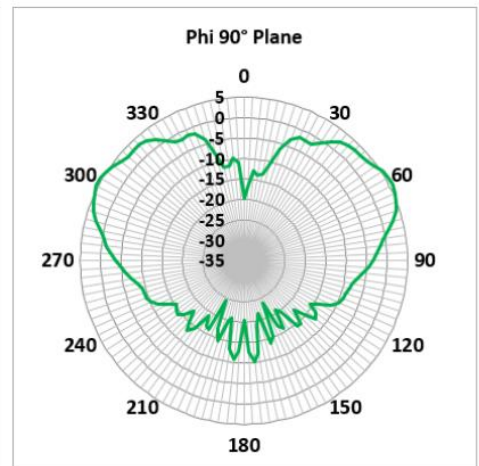
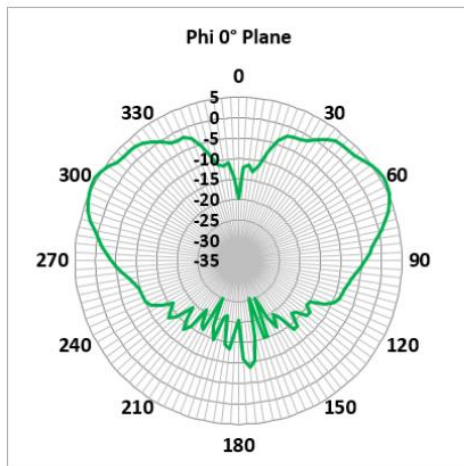
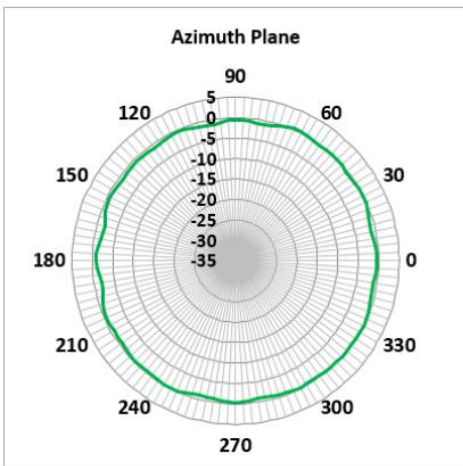

RADIATION PATTERNS (CONTINUED)

3800 MHz (FTRA6171M5Px)

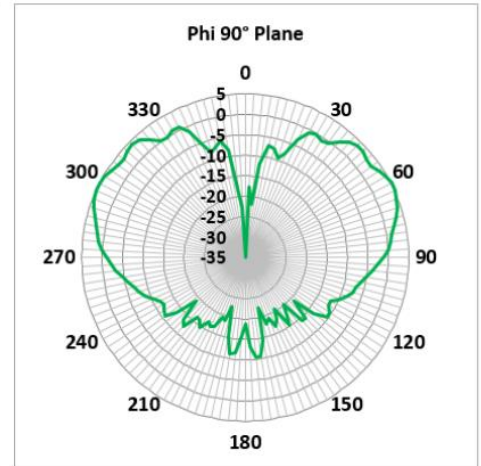
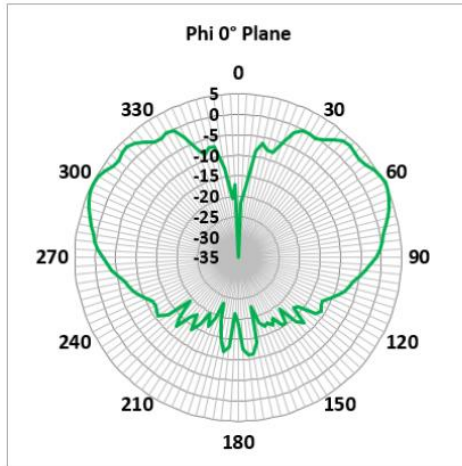
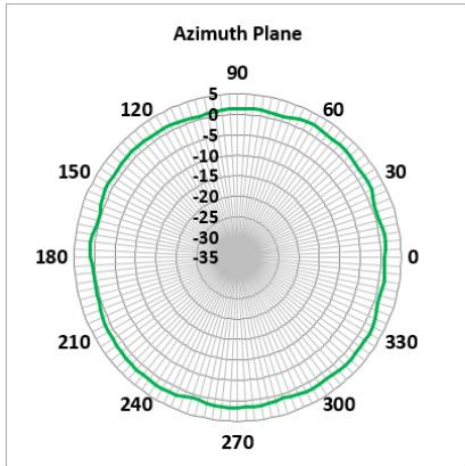

4200 MHz (FTRA6171M5Px)

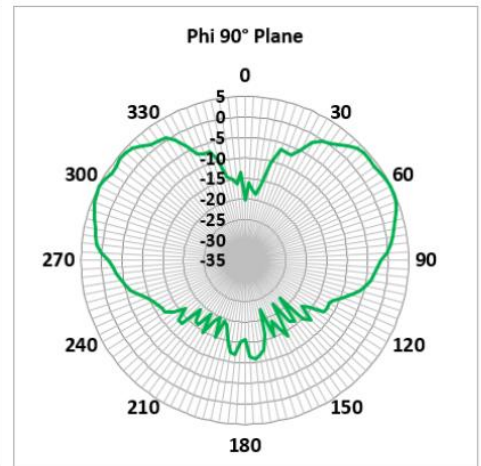
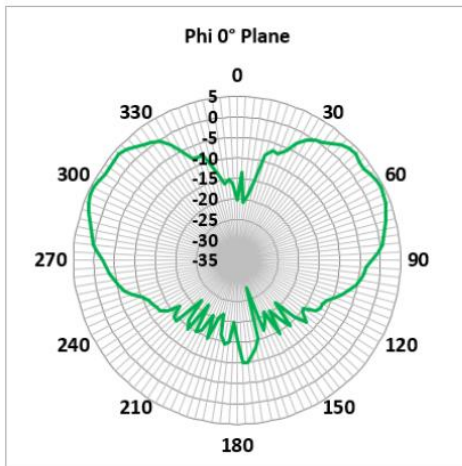
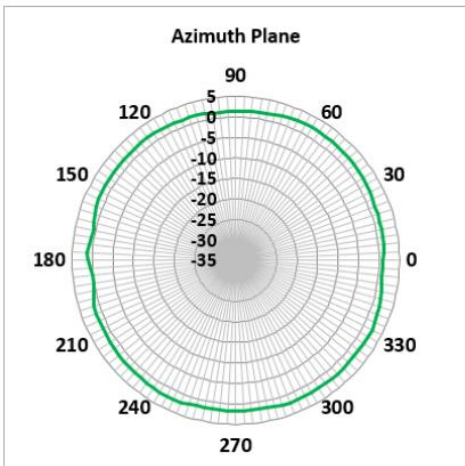

4400 MHz (FTRA6171M5Px)

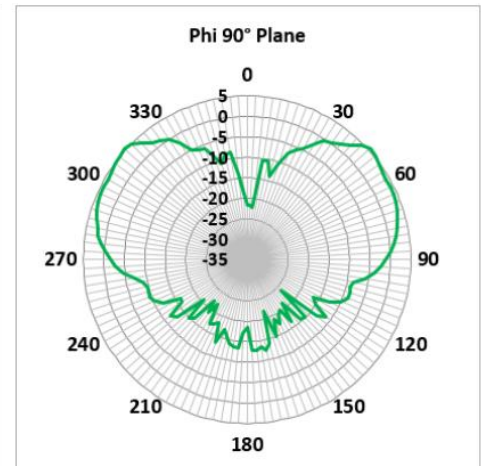
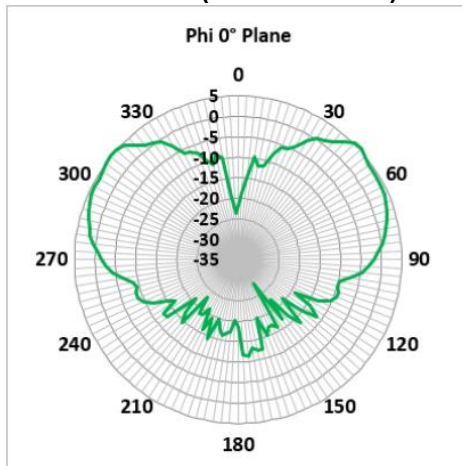
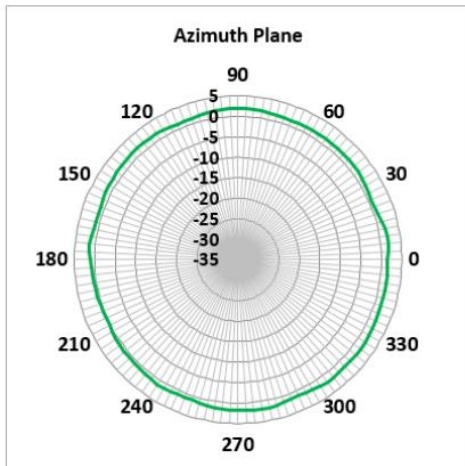

RADIATION PATTERNS (CONTINUED)

5150 MHz (FTRA6171M5Px)

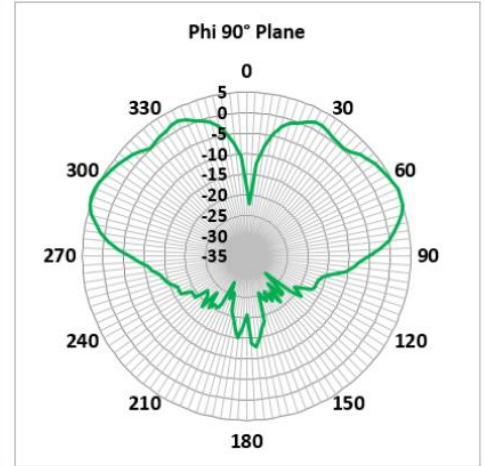
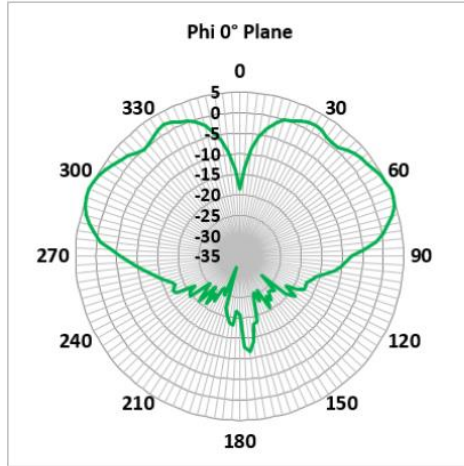
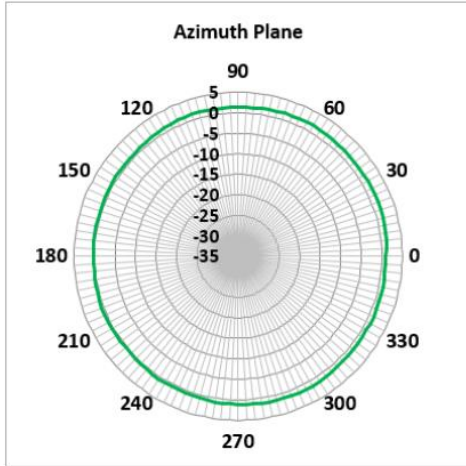

5470 MHz (FTRA6171M5Px)

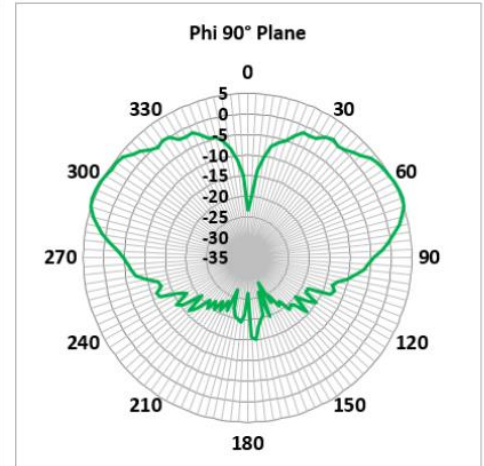
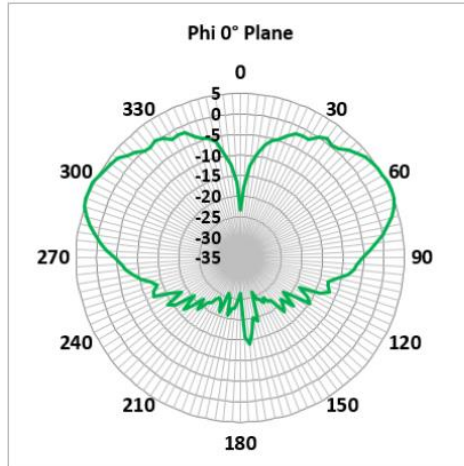
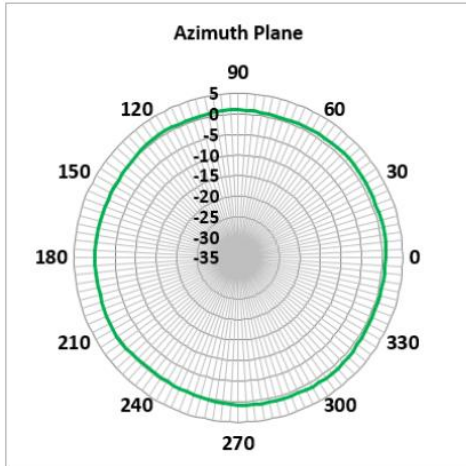

5925 MHz (FTRA6171M5Px)

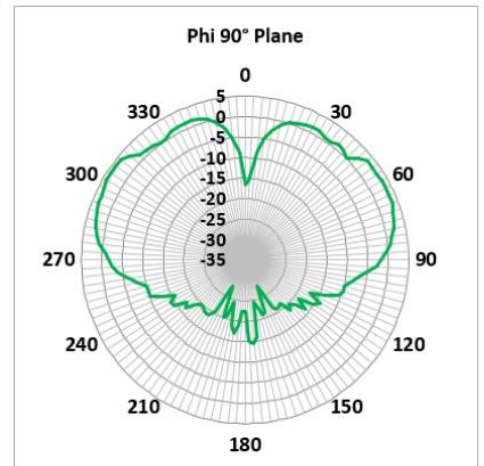
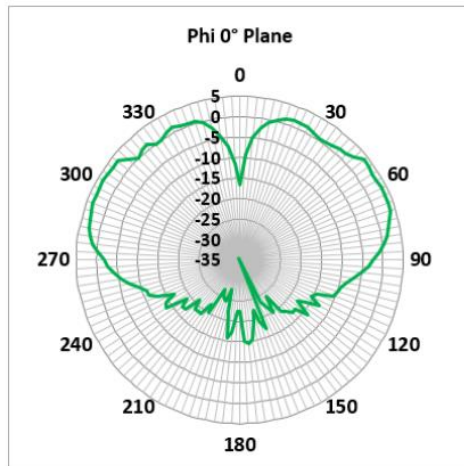
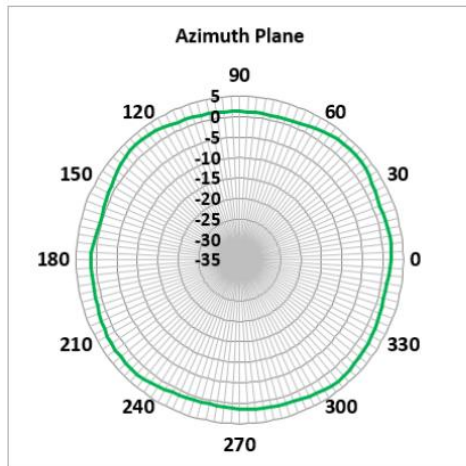

RADIATION PATTERNS (CONTINUED)

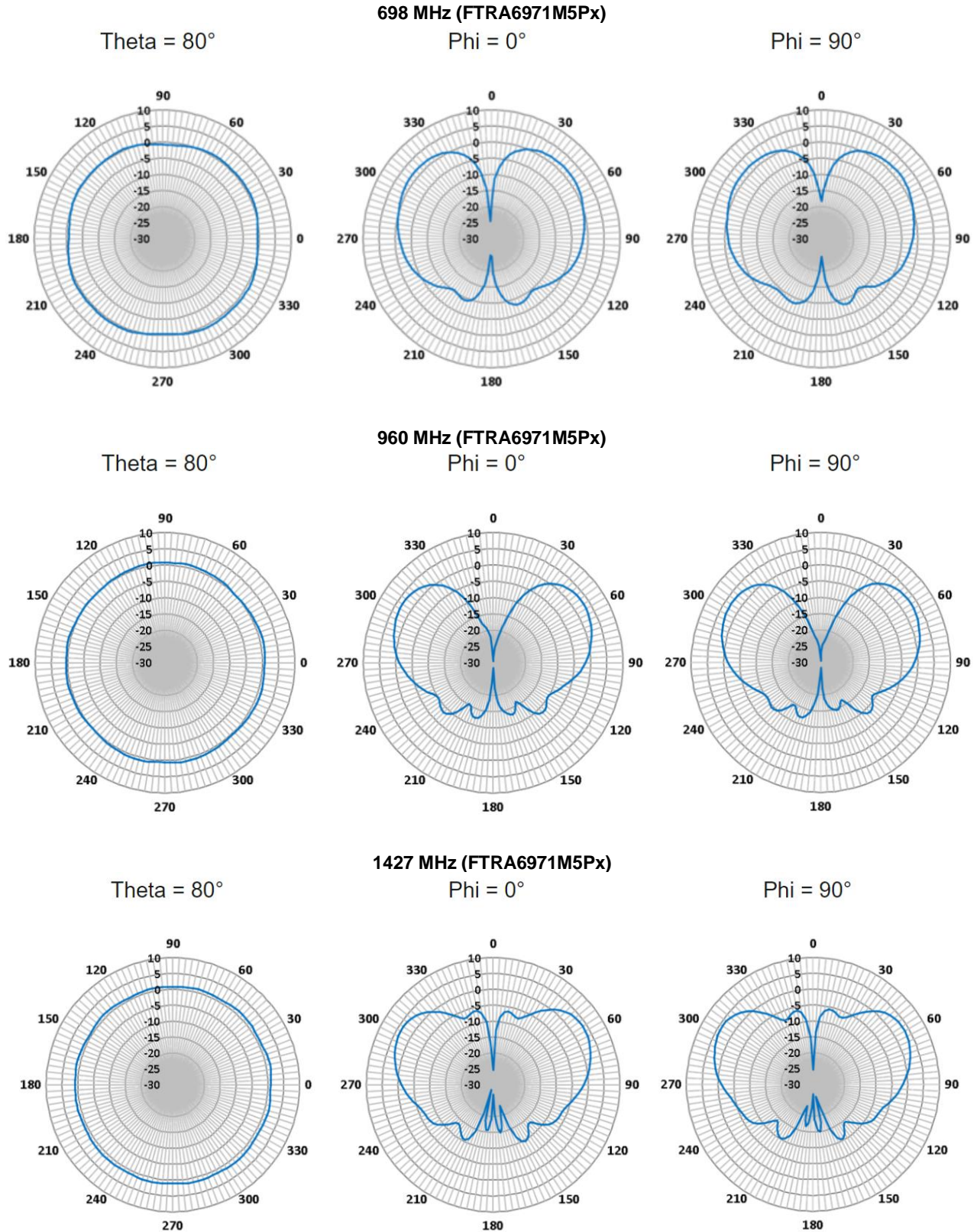

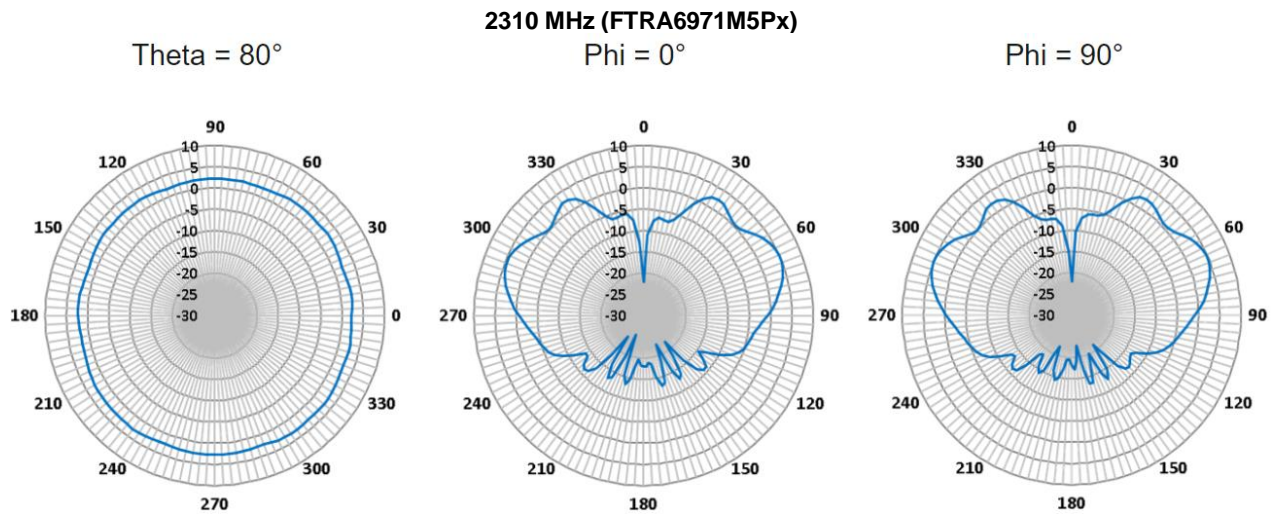
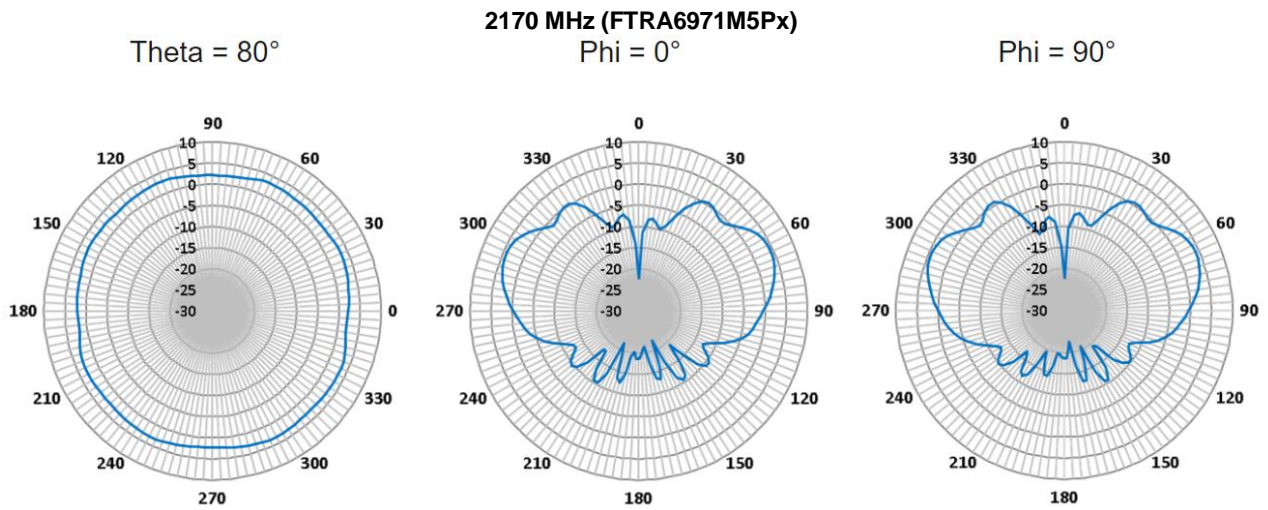
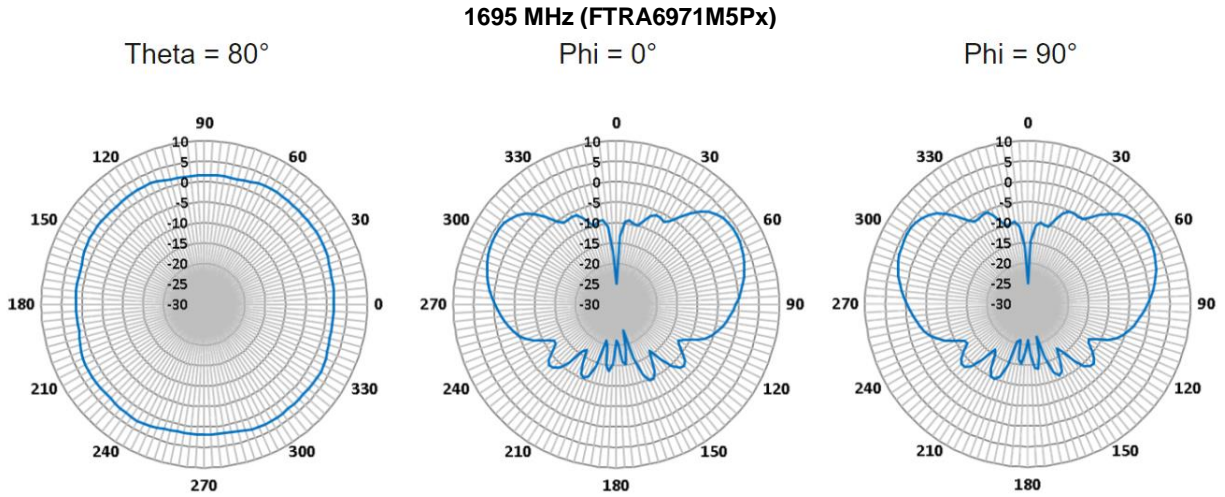

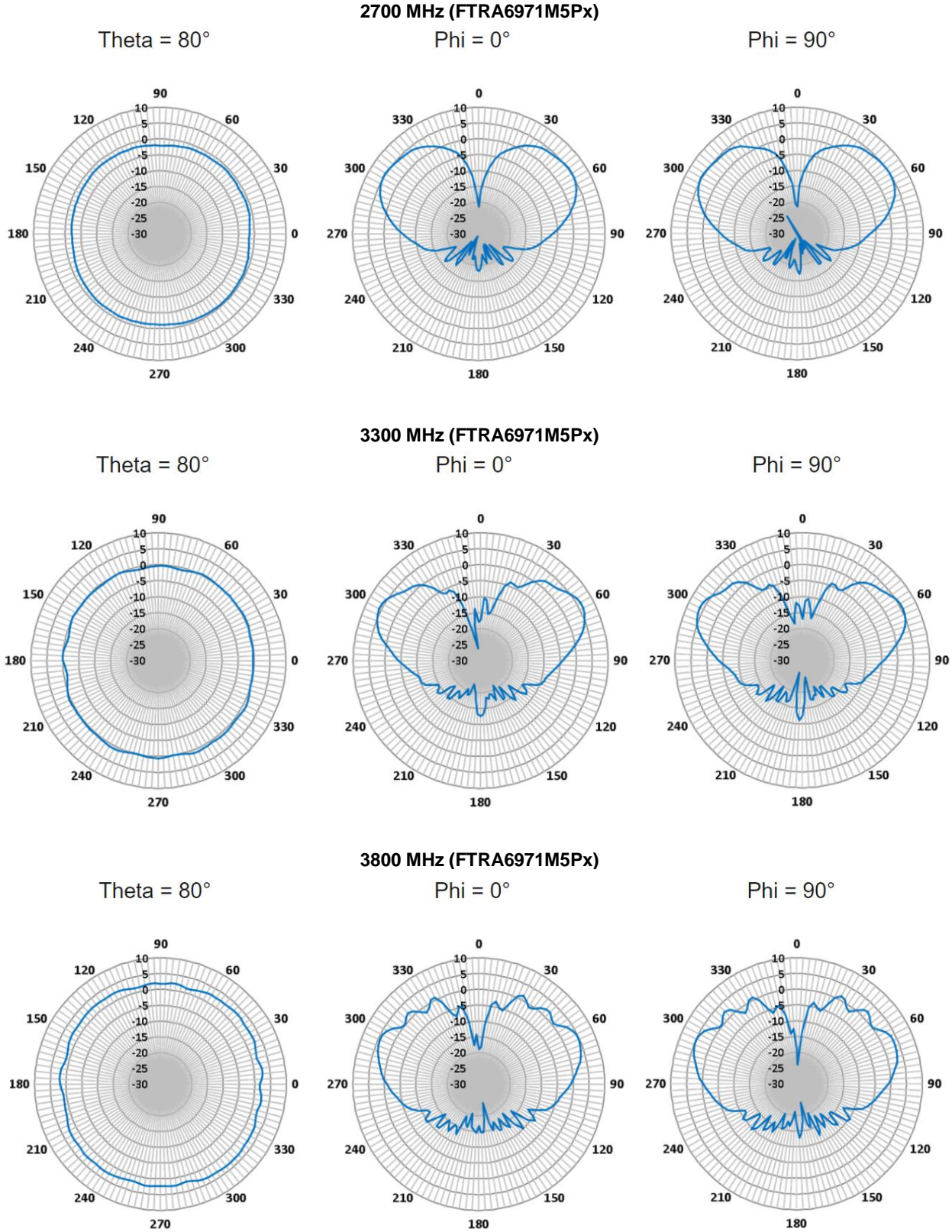

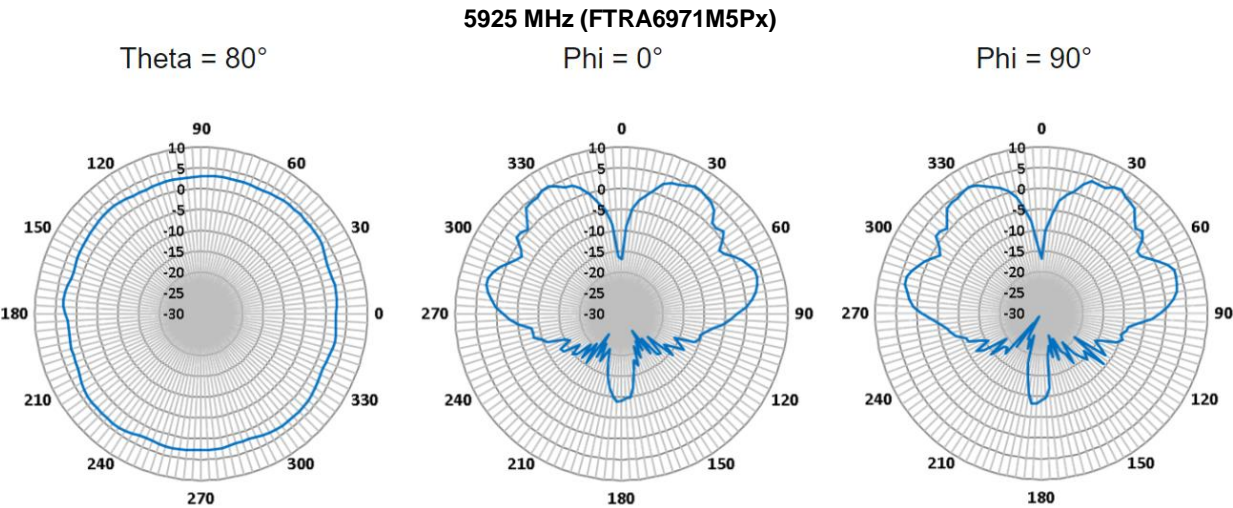
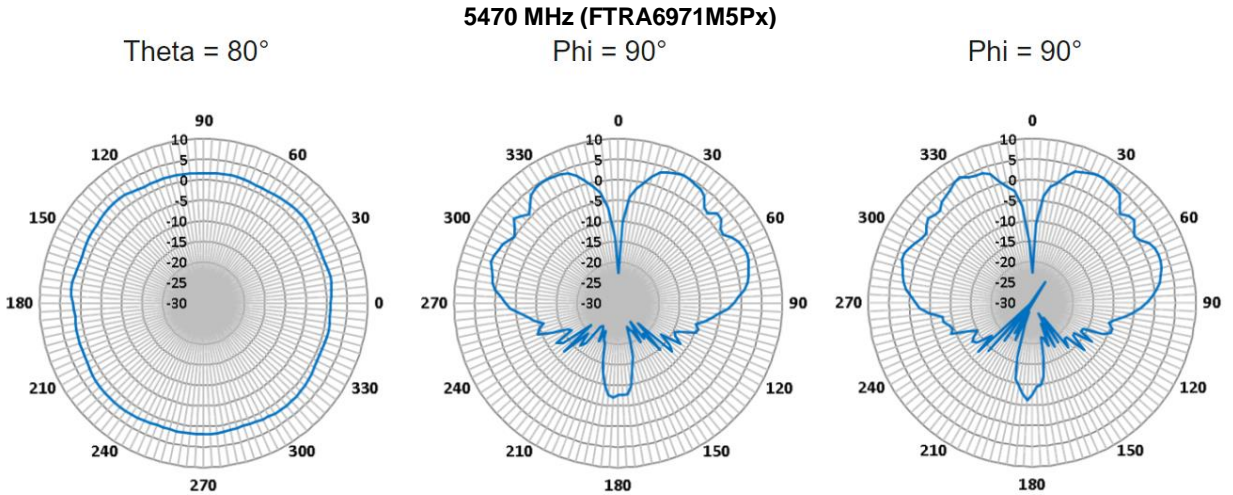

Laird Connectivity warrants to the original end user customer of its products that its products are free from defects in material and workmanship. Subject to conditions and limitations Laird Connectivity will, at its option, either repair or replace any part of its products that prove defective because of improper workmanship or materials. This limited warranty is in force for the useful lifetime of the original end product into which the Laird Connectivity product is installed. Useful lifetime of the original end product may vary but is not to exceed five (5) years from the original date of the end product purchase.

Any information furnished by Laird Connectivity and its agents is believed to be accurate and reliable. All specifications are subject to change without notice. Responsibility for the use and application of Laird Connectivity materials rests with the end user, since Laird Connectivity and its agents cannot be aware of all potential uses. Laird Connectivity makes no warranties as to the fitness, merchantability or suitability of any Laird Connectivity materials or products for any specific or general uses. Laird Connectivity shall not be liable for incidental or consequential damages of any kind. All Laird Connectivity products are sold pursuant to the Laird Connectivity Terms and Conditions of sale in effect from time to time, a copy of which will be furnished upon request.

© Copyright 2021 Laird Connectivity All Rights Reserved. Laird Connectivity, the Laird Connectivity logo, and other marks are trademarks or registered trademarks of Laird Connectivity or an affiliate company thereof. Other product or service names may be the property of third parties. Nothing herein provides a license under any Laird Connectivity or any third-party intellectual property rights.

sales@lairdconnect.com
support@lairdconnect.com
www.lairdconnect.com

