

Description

The AL5873Q is an automotive-grade three-channel linear LED driver with PWM dimming and analog dimming control. Each channel can drive up to 250mA with a total driving current up to 750mA. The LED channel current of the AL5873Q can be set by two reference resistors connected to the REF1 and REF2 pin.

The AL5873Q regulates LED current for each channel, accurate down to $\pm 4\%$, with excellent dimming performance. The AL5873Q enters standby mode to save power if no PWM signal is detected.

The AL5873Q monitors the temperature and reduces the LED current if the chip temperature exceeds the threshold temperature. And the input under voltage lock-out (UVLO), LED string open / short protection, over temperature protection (OTP), and fault indicator (FAULTB) are designed for automotive applications to improve system robustness.

The AL5873Q is available in TSSOP-16EP (Type DX) package.

Features

- AEC-Q100 Grade 1 Qualification
- Wide Input Voltage Range from 5V to 55V
- Each Channel Up to 250mA Current Capability
- Set Stop and Tail Current Independently Through 2 Resistors
- Switch LED Current Between Stop and Tail Function Automatically via FULL Input
- PWM Dimming via Both PWM Input and Power Supply
- Analog Dimming via ADIM Input
- Automatically Enter and Exit Standby Mode without Enable Pin
- Internal Protections:
 - Input Under Voltage Lock-Out (UVLO)
 - LED String Open Protection
 - LED String Short Protection
 - Over Temperature Protection (OTP)
- Thermal Fold-back if Chip Temperature Exceeds the Threshold
- Fault Reporting: UVLO, OTP, LED Open, and LED Short
- **Totally Lead-Free & Fully RoHS Compliant (Notes 1 & 2)**
- **Halogen and Antimony Free. "Green" Device (Note 3)**
- **The AL5873Q is suitable for automotive applications requiring specific change control; this part is AEC-Q100 qualified, PPAP capable, and manufactured in IATF 16949 certified facilities.**

<https://www.diodes.com/quality/product-definitions/>

Notes: 1. No purposely added lead. Fully EU Directive 2002/95/EC (RoHS), 2011/65/EU (RoHS 2) & 2015/863/EU (RoHS 3) compliant.
2. See <https://www.diodes.com/quality/lead-free/> for more information about Diodes Incorporated's definitions of Halogen- and Antimony-free, "Green" and Lead-free.
3. Halogen- and Antimony-free "Green" products are defined as those which contain <900ppm bromine, <900ppm chlorine (<1500ppm total Br + Cl) and <1000ppm antimony compounds.

Pin Assignments

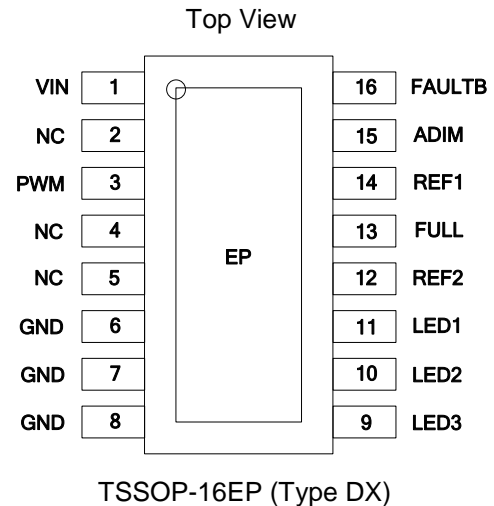

Applications

- Automotive LED Inner Lamps
- Rear Light – Tail and Stop Light, Rear Turn Indicator, Parking Light, Fog Light, Reverse Light

Typical Applications Circuit

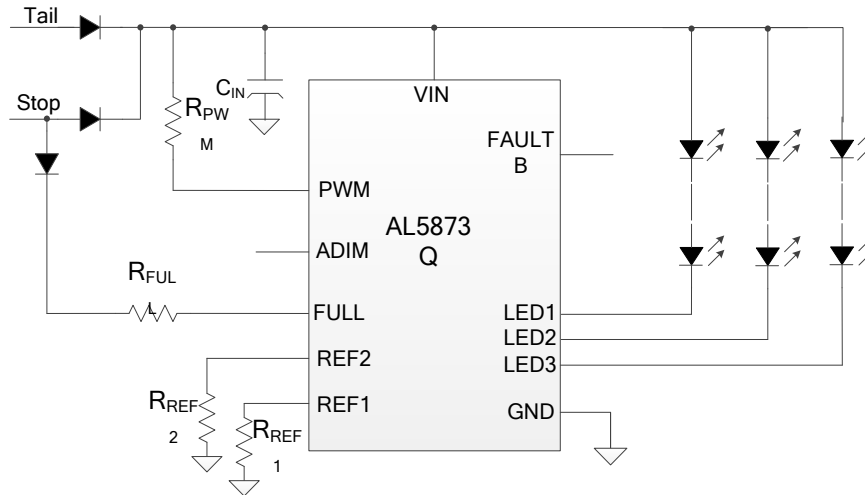

Figure 1. Typical Application

Pin Descriptions

Pin Number	Pin Name	Description
VIN	1	Power Supply for LED Driver
NC	2, 4, 5	No Connection
PWM	3	PWM Signal Input for Channel 1 to 3, Internally Pulled Down. This pin also serves as enable function of chip. The chip enters standby mode when the PWM pin is pulled to ground longer than 25ms.
GND	6, 7, 8	Ground for LED Driver
LED3	9	Channel 3 LED Cathode
LED2	10	Channel 2 LED Cathode
LED1	11	Channel 1 LED Cathode
REF2	12	Stop Reference Current Setting, Enabled When FULL is Pulled High.
FULL	13	Select LED Current Level Set by External Resistor. When FULL pin is pulled high, the LED current is set by resistor connected to REF2 pin; When FULL pin is pulled low, the LED current is set by resistor connected to REF1 pin. When FULL pin is left floating, this pin is pulled to ground by internal current sink.
REF1	14	Tail Reference Current Setting
ADIM	15	Analog Dimming Input for All Channels. Drive with DC voltage ($0.3V < V_{ADIM} < 1.5V$) to adjust output current from 0 to 100%.
FAULTB	16	Fault Report. Asserted Low to report faulty conditions.
Exposed PAD	Exposed PAD	Exposed Pad. Internally connected to GND. It should be externally connected to GND and thermal mass for enhanced thermal impedance. It should not be used as electrical conduction path.

Functional Block Diagram

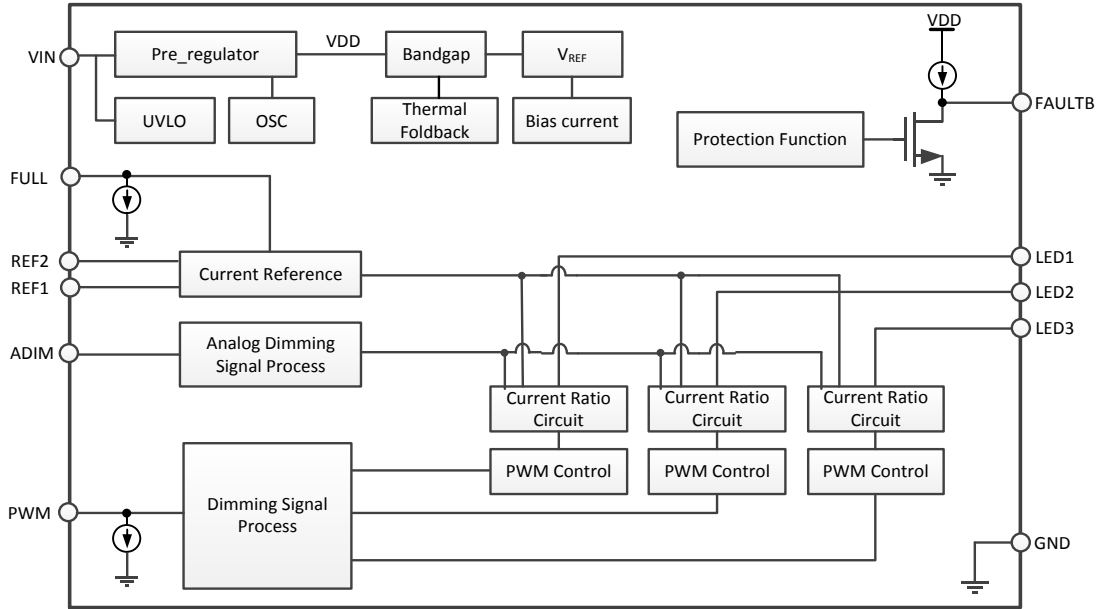

Figure 3. Functional Block Diagram

Absolute Maximum Ratings (Note 4)

Symbol	Parameter	Ratings	Units
V _{VIN}	Input Voltage Relative to GND	-0.3 to +65	V
V _{LEDX} , V _{PWM} , V _{FULL} , V _{FAULTB}	LED _x , PWM, FULL and FAULTB Voltage Relative to GND	-0.3 to +65	V
V _{REF1} , V _{REF2} , V _{ADIM}	REF1, REF2 and ADIM Voltage Relative to GND	-0.3 to +6	V
T _J	Operating Junction Temperature	-40 to +150	°C
T _{ST}	Storage Temperature	-55 to +150	°C
θ _{JA}	Junction-To-Ambient Thermal Resistance	45	°C/W
θ _{JC}	Junction-To-Case (Top) Thermal Resistance	10	°C/W
—	Human-Body Model (HBM)	2000	V
—	Charged-Device Model (CDM)	1000	V

Notes: 4. Stresses greater than the 'Absolute Maximum Ratings' specified above, can cause permanent damage to the device. These are stress ratings only; functional operation of the device at these or any other conditions exceeding those indicated in this specification is not implied. Device reliability can be affected by exposure to absolute maximum rating conditions for extended periods of time. Semiconductor devices are ESD sensitive and may be damaged by exposure to ESD events. Suitable ESD precautions should be taken when handling and transporting these devices.
5. Device mounted on 2" x 2" FR-4 substrate PCB, 2oz copper, with minimum recommended pad on top layer and thermal vias to bottom layer ground plane.

Recommended Operating Conditions

Symbol	Parameter	Min	Max	Unit
V _{VIN}	Input Voltage Relative to GND	5	55	V
F _{PWM}	PWM Frequency	0.2	1	kHz
I _{LEDX}	LED _x Output Current (Note 6)	0	250	mA
V _{IH}	High-Level Input Voltage on PWM	1.4	5.5	V
V _{IL}	Low-Level Input Voltage on PWM	0	0.4	V
T _J	Operating Junction Temperature Range	-40	+150	°C
T _A	Operating Ambient Temperature	-40	+125	°C

Electrical Characteristics (@ $T_A = -40^{\circ}\text{C}$ to $+125^{\circ}\text{C}$, $V_{IN} = +12\text{V}$, unless otherwise specified.)

Symbol	Parameter	Test Conditions	Min	Typ	Max	Unit
V_{VIN_UVLO}	VIN UVLO Voltage	V_{VIN} Rising	4.75	5.0	5.25	V
$V_{VIN_UVLO_HYS}$	VIN UVLO Hysteresis	V_{VIN} Falling	—	300	—	mV
$I_{VIN_Standby}$	Input Current in Standby Mode	Standby Mode, PWM is "Low" for 7ms	—	186	—	μA
I_{DVCC_Q}	Input Current in Normal Mode	Enabled, LED _X Floating, PWM is "H", R _{SET} is 48k Ω	—	0.7	—	mA
V_{IL_PWM}	PWM Low Voltage	—	—	—	0.4	V
V_{IH_PWM}	PWM High Voltage	—	1.4	—	—	V
I_{PWM_PD}	PWM Internal Pulldown	$V_{PWM} = 5\text{V}$	0.35	—	3.5	μA
T_{PWM_SHDN}	Entrance Time for Standby Mode When the PWM is "L"	—	—	15	25	ms
V_{ADIM}	Typical Voltage Range for Analog Dimming	For Analog Dimming 0% For Analog Dimming 100%	—	0.3 1.5	—	V
V_{ADIM_ON}	Apply DC Voltage on ADIM Pin for Analog Dimming on	V_{ADIM} Rising	—	—	0.35	V
V_{ADIM_OFF}	Apply DC Voltage on ADIM Pin for Analog Dimming off	V_{ADIM} Falling	0.15	—	—	V
I_{ADIM}	ADIM sourcing Current	—	19	20	22	μA
V_{REF1}	Reference Voltage 1	(Note 6 & 7)	1.47	1.5	1.53	V
V_{REF2}	Reference Voltage 2	(Note 6 & 7)	1.47	1.5	1.53	V
I_{LED_NOM}	Regulation Current for Channel 1	R _{SET} = 48k Ω (Note 6 & 7)	—	125	—	mA
V_{LEDX_REG}	Minimum LED Regulation Voltage	$I_{LEDX} = 125\text{mA}$	—	0.5	—	V
I_{LEDX_LEAK}	LED _X Leakage Current	$V_{PWM} = 0\text{V}$, $V_{LEDX} = 12\text{V}$	—	0.1	5	μA
$I_{LEDX_ACCURACY}$	LED Current Accuracy	R _{SET} = 48k Ω	-4	—	4	%
I_{LEDX_MATCH}	LED Channel Current Matching	R _{SET} = 48k Ω	-3	—	3	%
$T_{LEDXSHDG}$	Short-Detection Deglitch	100% Duty-Cycle	—	5	—	ms
$N_{LEDXSHDG}$		PWM Dimming (count the number of continuous cycles when LED short is detected)	—	7	—	Cycles
T_{LEDXSH_HICCUP}	LED Short Protection Hiccup Time	—	—	128	—	ms
$T_{LEDXOPDG}$	Open-Detection Deglitch	100% Duty-Cycle	—	5	—	ms
$N_{LEDXOPDG}$		PWM Dimming (count the number of continuous cycles when LED open is detected)	—	7	—	Cycles
$T_{LEDXOPDG_CYCLE}$	Open-Detection Deglitch Time per Cycle	—	—	20	—	us
T_{LEDXOP_HICCUP}	LED Open Protection Hiccup Time	—	—	128	—	ms
V_{IL_FULL}	FULL Low Voltage	—	—	—	0.4	V
V_{IH_FULL}	FULL High Voltage	—	1.4	—	—	V
I_{PD_FULL}	FULL Pull Down Current	—	—	2	—	μA
I_{F_PULLUP}	FAULTB Pull-Up Current	$V_{FAULTB} = 1.6\text{V}$	—	500	—	μA
V_{F_PULLUP}	FAULTB Pull-Up Voltage	Fault Pin Floating	—	3	—	V
V_{FOL}	FAULTB Output Low Voltage	$I_{FAULTB} = 1\text{mA}$	—	—	600	mV
V_{FIN_TH}	FAULTB Input Detect Threshold Voltage	—	—	1.33	—	V
I_{F_LKG}	FAULTB Leakage Current	$V_{FAULTB} = 5\text{V}$	—	—	5	μA
T_{SHDN}	Thermal Shutdown Threshold	—	—	160	—	$^{\circ}\text{C}$
T_{REC}	Thermal Recovery Threshold	—	—	130	—	$^{\circ}\text{C}$

- Notes:
- Subject to maximum junction temperature of $+150^{\circ}\text{C}$ not being exceeded. The Maximum ambient temperature range is limited by device power dissipation; such that its junction temperature should be kept less than or equal to $+150^{\circ}\text{C}$. See Page 11 for more information on power dissipation.
 - Subject to thermal fold back function, the current of each channel is become smaller than specs when the junction temperature is higher than thermal fold back trigger point. See Page xx for more information on thermal fold back function.

Typical Performance Characteristics ($T_A = +25^\circ\text{C}$, $V_{IN} = 12\text{V}$, $R_{REF} = 48\text{k}\Omega$, $I_{LED} = 125\text{mA}$, unless otherwise noted.)

VIN Standby Current vs. Input Voltage

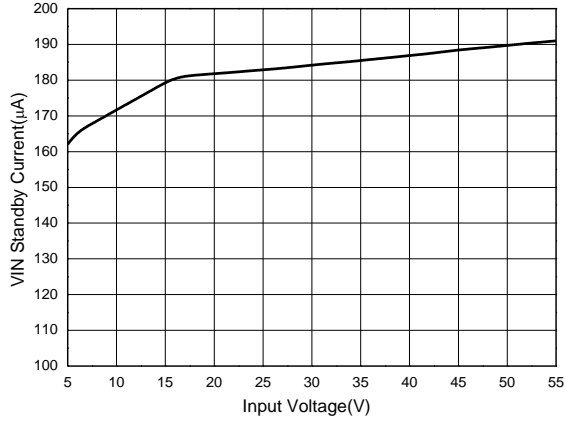

VIN Standby Current vs. Temperature

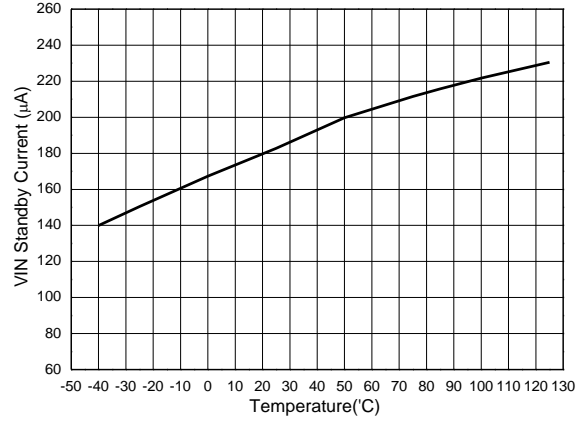

VIN Quiescent Current vs. Input Voltage

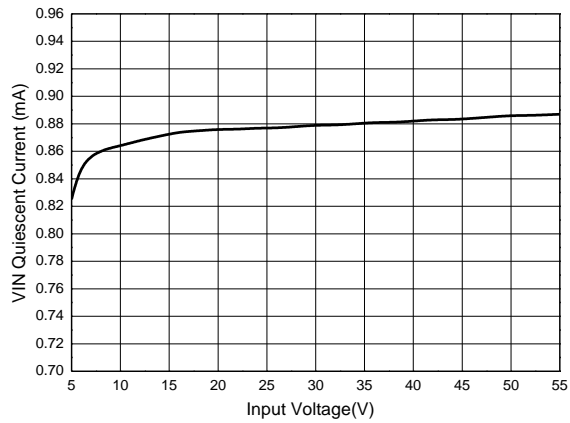

VIN Quiescent Current vs. Temperature

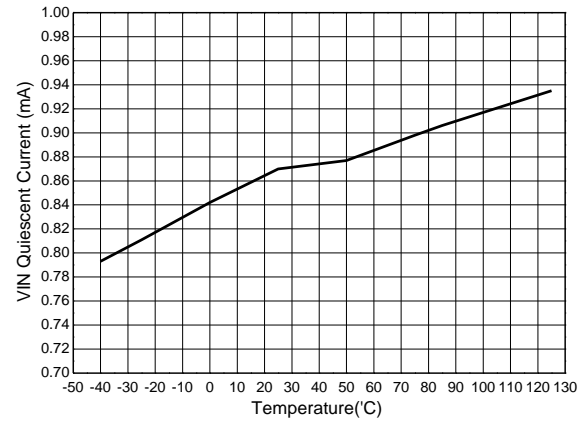

Reference Voltage vs. Input Voltage

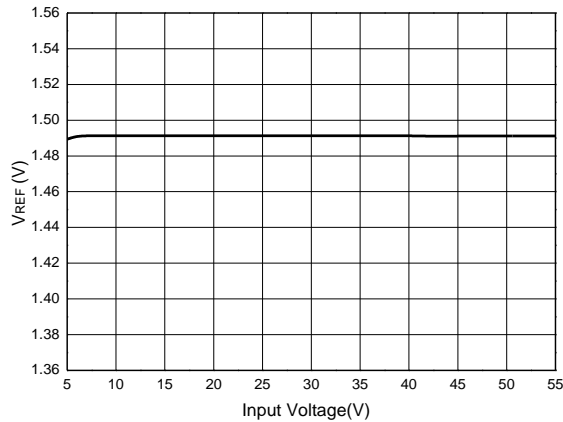

Reference Voltage vs. Temperature

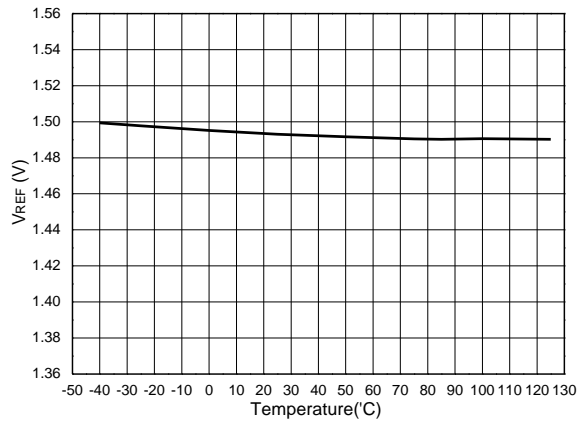

Typical Performance Characteristics ($T_A = +25^\circ\text{C}$, $V_{IN} = 12\text{V}$, $R_{REF} = 48\text{k}\Omega$, $I_{LED} = 125\text{mA}$, unless otherwise noted.)
(continued)

ADIM Sourcing Current vs. ADIM Voltage

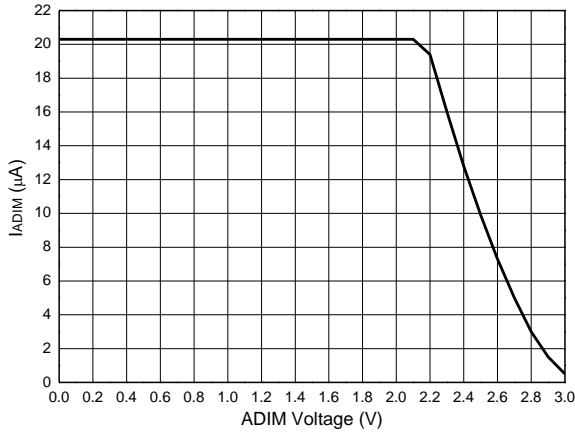

ADIM Sourcing Current vs. Temperature

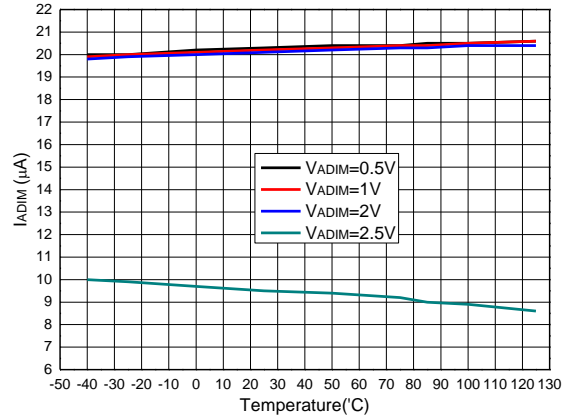

FAULT Sourcing Current vs. FAULT Voltage

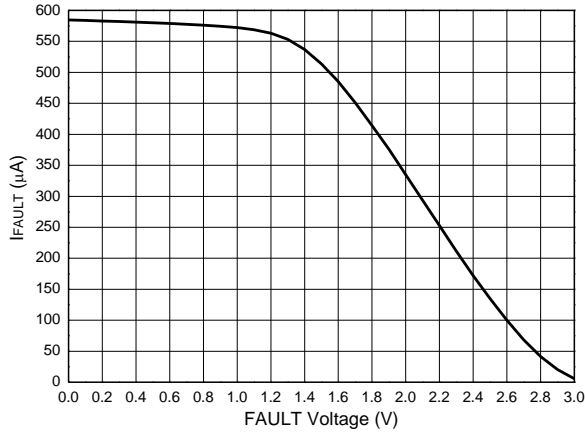

FAULT Sourcing Current vs. Temperature

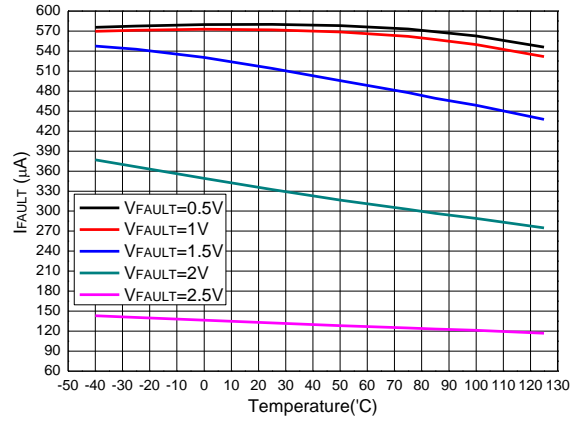

FAULT Input Detection Threshold vs. Temperature

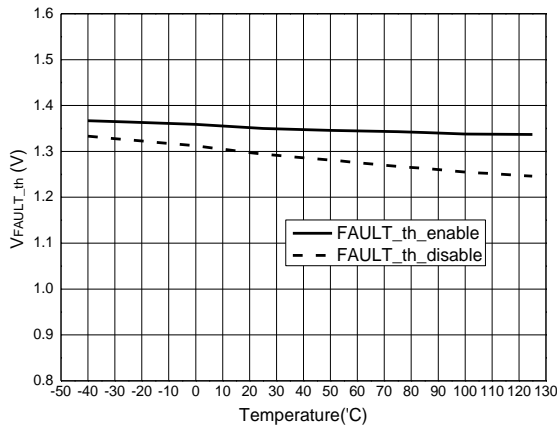

VIN UVLO Voltage vs. Temperature

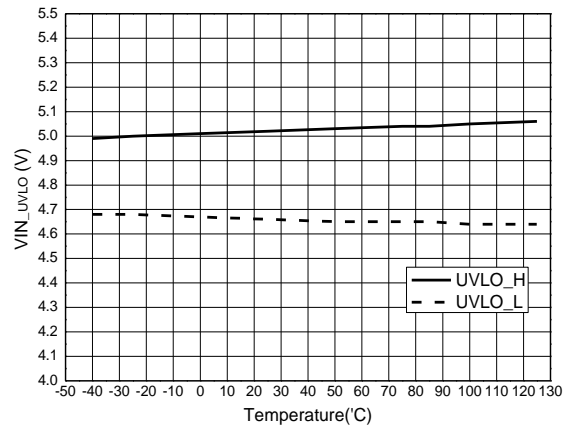

Typical Performance Characteristics ($T_A = +25^\circ\text{C}$, $V_{IN} = 12\text{V}$, $R_{REF} = 48\text{k}\Omega$, $I_{LED} = 125\text{mA}$, unless otherwise noted.)
(continued)

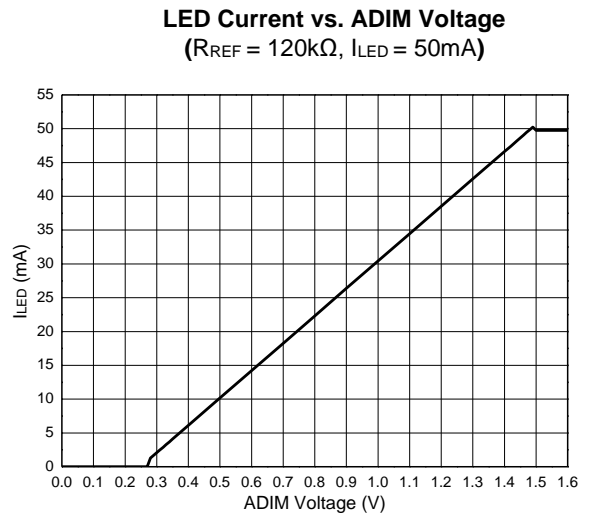
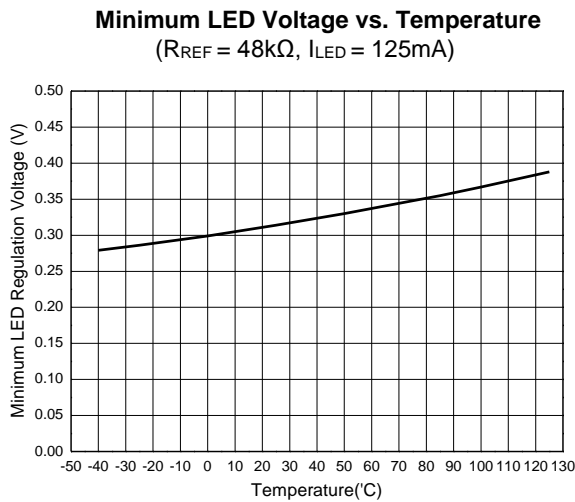
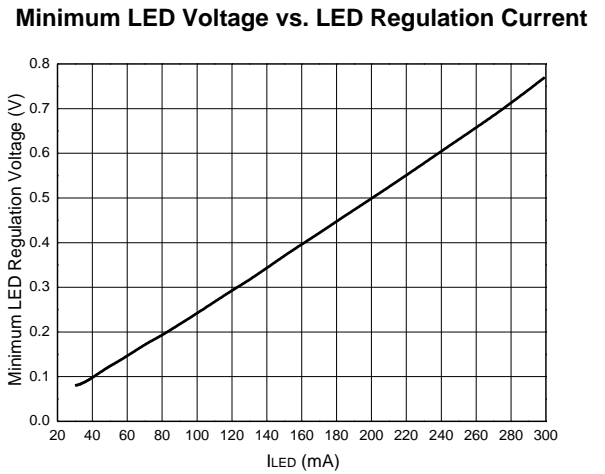
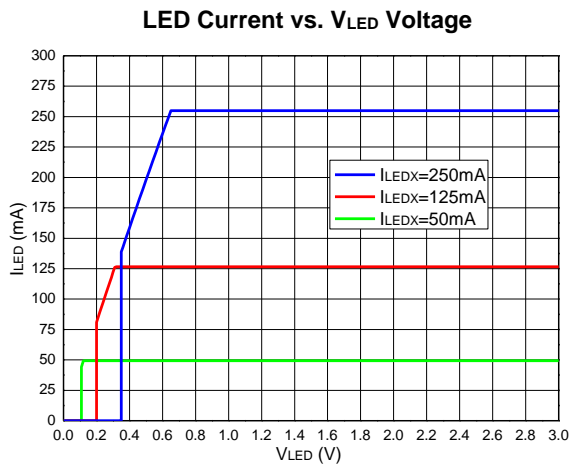
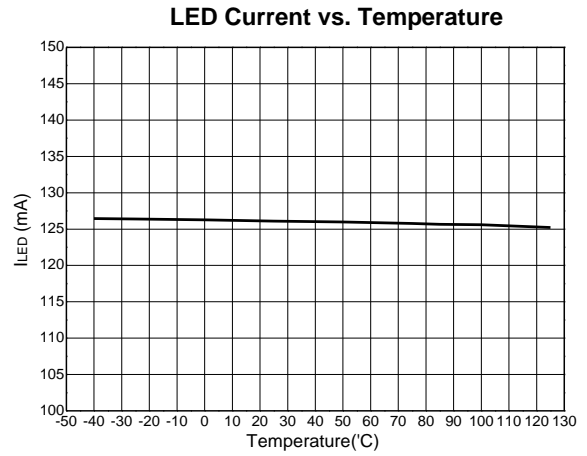
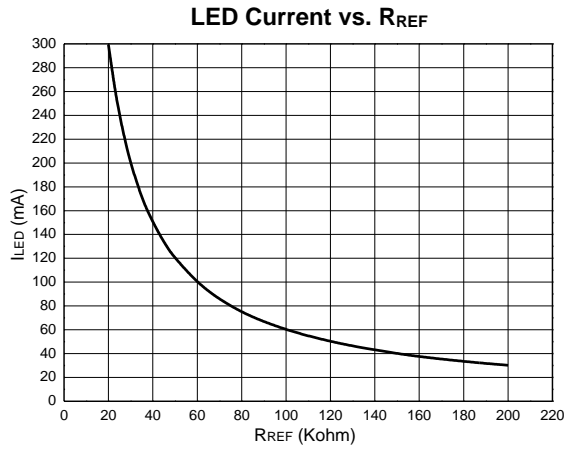

Typical Performance Characteristics ($T_A = +25^\circ\text{C}$, $V_{IN} = 12\text{V}$, $R_{REF} = 48\text{k}\Omega$, $I_{LED} = 125\text{mA}$, unless otherwise noted.)
(continued)

LED Current vs. ADIM Voltage
($R_{REF} = 48\text{k}\Omega$, $I_{LED} = 125\text{mA}$)

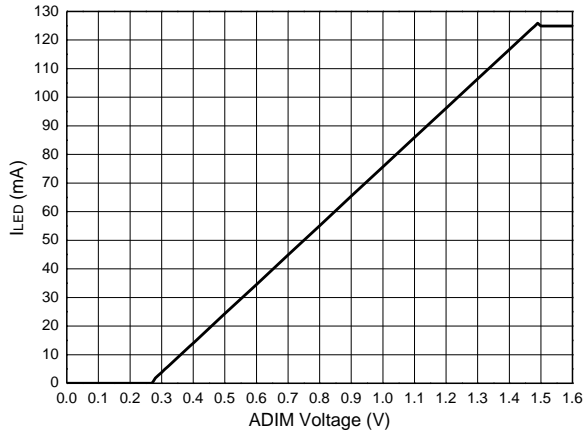

LED Current vs. ADIM Voltage
($R_{REF} = 24\text{k}\Omega$, $I_{LED} = 250\text{mA}$)

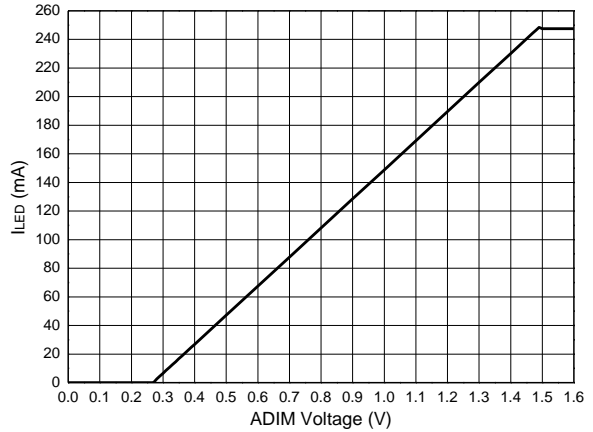

LED Current vs. PWM Duty Cycle
($R_{REF} = 120\text{k}\Omega$, $I_{LED} = 50\text{mA}$, 0~100% Duty)

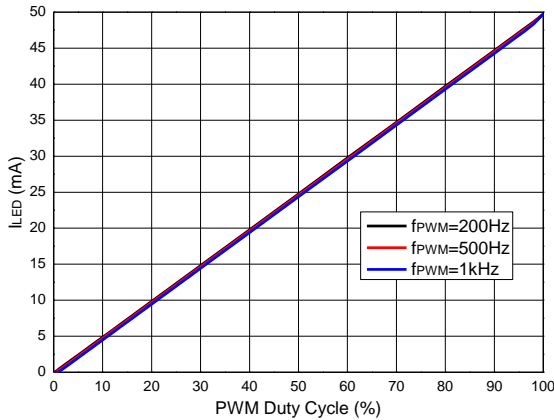

LED Current vs. PWM Duty Cycle
($R_{REF} = 120\text{k}\Omega$, $I_{LED} = 50\text{mA}$, 0~20% Duty)

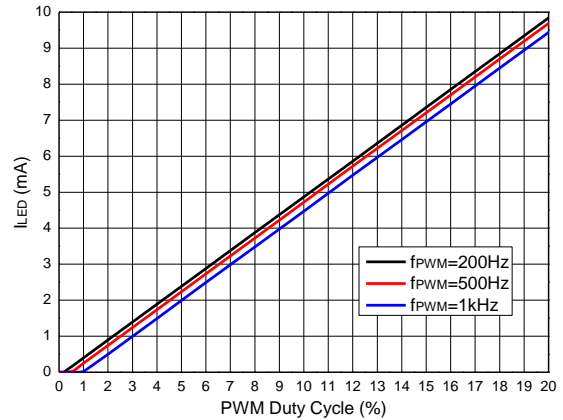

Typical Performance Characteristics ($T_A = +25^\circ\text{C}$, $V_{IN} = 12\text{V}$, $R_{REF} = 48\text{k}\Omega$, $I_{LED} = 125\text{mA}$, unless otherwise noted.)
(continued)

LED Current vs. PWM Duty Cycle
($R_{REF} = 48\text{k}\Omega$, $I_{LED} = 125\text{mA}$, 0~100% Duty)

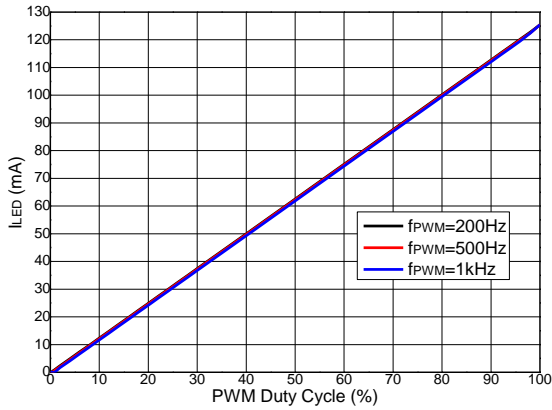

LED Current vs. PWM Duty Cycle
($R_{REF} = 48\text{k}\Omega$, $I_{LED} = 125\text{mA}$, 0~20% Duty)

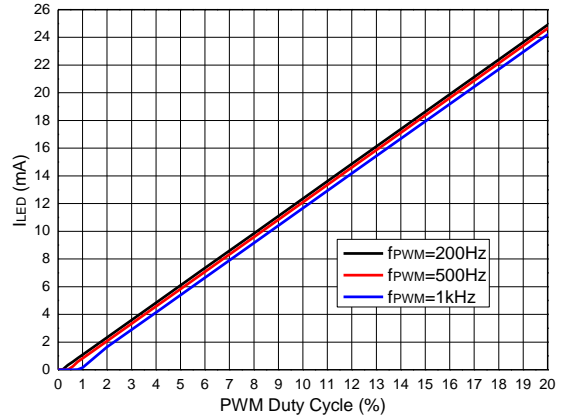

LED Current vs. PWM Duty Cycle
($R_{REF} = 24\text{k}\Omega$, $I_{LED} = 250\text{mA}$, 0~100% Duty)

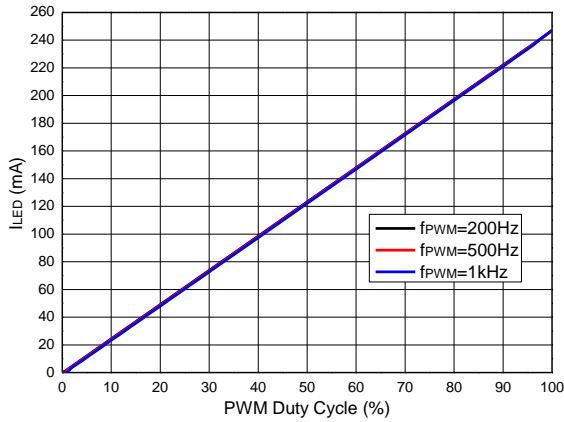

LED Current vs. PWM Duty Cycle
($R_{REF} = 24\text{k}\Omega$, $I_{LED} = 250\text{mA}$, 0~20% Duty)

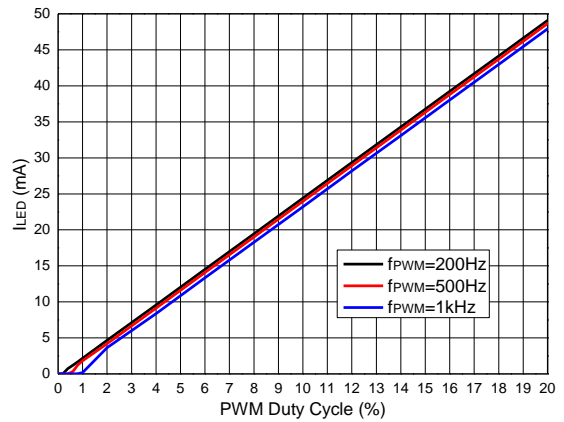

Function Description

The AL5873Q is a cost-effective three-channel, constant-current linear driver optimized for automotive LED applications. Each channel can drive up to 250mA with a total driving current up to 750mA. The channel can be controlled by digital PWM signal or analog dimming signal. The integrated low-side current sinks allow LED common-anode connections for cost effectiveness or different anode voltages for efficiency optimization.

The AL5873Q detects fault conditions and reports its status on the FAULTB pin. It features LED open detection, LED short detection, Over Temperature Protection (OTP), and Under Voltage Lockout (UVLO).

Integrated thermal foldback function reduces the regulated current level at high junction temperatures to limit power dissipation.

LED Current Setting

The AL5873Q channel current is set by the current setting resistor RREF1 or RREF2. Figure 4 illustrates LED current setting with FULL pin status.

Given that FULL = low, the LED channel current is pulse-width modulated at 200Hz frequency with fixed 25% duty cycle, and the amplitude of the LED channel current is set by RREF1. The average LED channel current is expressed as below:

$$I_{LEDX} = 4000 \times \frac{V_{REF1}}{R_{REF1}} \times 25\%$$

Given that FULL = high, the LED channel current is set by RREF2. The LED channel current level is expressed as below:

$$I_{LEDX} = 4000 \times \frac{V_{REF2}}{R_{REF2}}$$

Where VREF1 and VREF2 are nominally 1.5V, ILEDX is in mA, and RREF1 and RREF2 are in kΩ. For example, if RREF1 and RREF2 are both 24kΩ, the AL5873Q provides 250mA / 62.5mA output current per channel when FULL = high / low.

While the recommended maximum ILED1, ILED2 and ILED3 are at 250mA for the AL5873Q, by setting RREF2 at 24kΩ, the system design can drive an LED string with higher current by connecting the cathodes of the LED string to two or more LED channel outputs (LEDx). The total current through the LED string is the sum of the current through the individual channels.

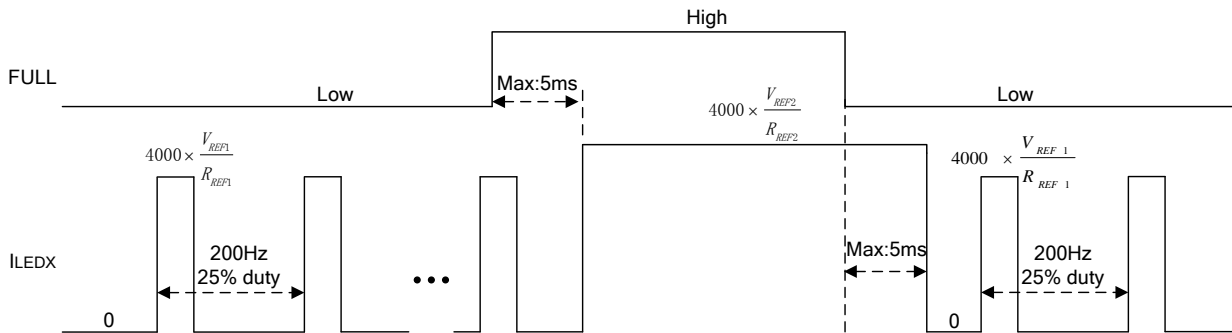

Figure 4. Current Setting Diagram

Under Voltage Lockout

Under-voltage lockout function (UVLO) guarantees that the device is initially off during start-up. The AL5873Q is not turned on until the power supply has reached 5.0V. Whenever the input voltage falls below approximately 4.7V, the device is turned off. The UVLO circuit has a hysteresis of 300mV. FAULTB status will be reported when UVLO happens.

Enable and Start-up LED Drivers

The AL5873Q is enabled when the voltage at the PWM pin is greater than typical voltage of 1.4V, and disabled when the PWM is lower than 0.4V. Upon the PWM pin is asserted and VIN pin is ramped up beyond minimum operation voltage, a start-up process will be performed. When the PWM is pulled to ground longer than 25ms, the LED Driver will enter standby mode with ultra-low standby current.

Standby Mode

When PWM pin is pulled down to voltage lower than 0.4V for 25ms or longer, the AL5873Q will automatically enter the standby mode for power saving purpose. When in the standby mode, most of blocks in the AL5873Q are turned off to reduce the quiescent supply current. When the PWM pin is pulled up to voltage higher than 1.4V, the AL5873Q will automatically exit the standby mode and perform its designated functions properly.

Function Description (continued)

PWM Dimming Control

The AL5873Q features PWM dimming control for three output channels. High level of PWM signal will turn on the current sink to flow current through the LED and low level will turn it off. Consequently, the LED current and LED brightness of each channel can be adjusted in according to the duty cycle of PWM signal. The PWM frequency is recommended to be greater than 200Hz and less than 1kHz for better dimming linearity.

Analog Dimming Control

In addition to PWM dimming, the AL5873Q also provides an analog dimming feature on the ADIM pin. The LED current can be linearly adjusted from 0 to 100% by varying the voltage at ADIM pin from 0.3V to 1.5V. The AL5873Q shuts all channel currents when the voltage on ADIM pin is lower than 0.15V. The LED current is constant, rather than switching during PWM dimming.

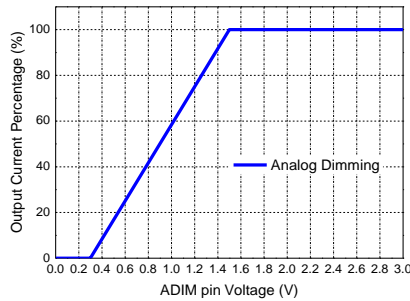

Figure 5. Analog Dimming Curve

Thermal Foldback and Over Temperature Protection

The AL5873Q integrates over Temperature protection to prevent the device from overheating. When the junction temperature of IC is higher than 160 °C, the device will enter OTP in which all current sinks are shut down and no current flows to LED strings. When the chip is cooled down and temperature is lower than 130°C, the AL5873Q will trigger a start-up process and the LED current will be automatically restored to its set current value. OTP protection is reported on the FAULTB pin.

In addition, to prevent LEDs from flickering because of rapid thermal changes, the AL5873Q features thermal fold back function to reduce power dissipation at high junction temperatures. As shown in figure 6, the AL5873Q reduces the LED current as the silicon junction temperature of device increases above the threshold temperature (135°C). As the temperature rising, the LED current drop down to 50% of nominal value and keep constant. If the junction temperature of IC is continually rising above 160 °C, the OTP will be triggered and shut down the LED current. By mounting the AL5873Q on the same thermal substrate with LEDs, use of this feature can also limit the dissipation of the LEDs, protect the IC and LEDs.

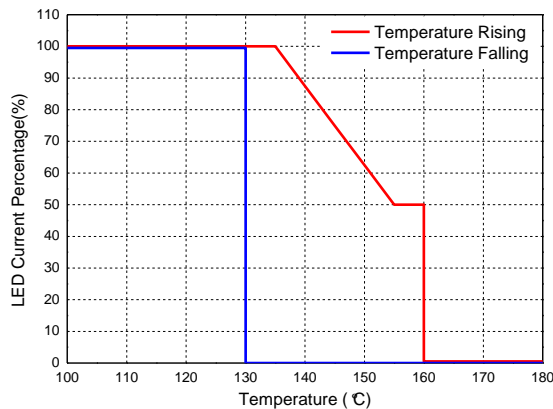

Figure 6. Thermal Fold-back Diagram

Function Description (continued)

LED Open Protection

The AL5873Q detects the LED open status by monitoring the current and voltage status of the LED strings. The voltage at LEDx pin is compared with a reference voltage proportional to LED current. The comparator will output high if the voltage at LEDx pin is smaller than reference voltage. When LED opens and lasts for a short time period, the AL5873Q enters protection and shuts down all channels. The time period is 7 cycles of the input PWM signal or 5ms timer when the PWM duty is 100%. The abnormal channel will be periodically rechecked every 128ms afterward to check if the abnormal condition is cleared. The LED driver will be re-activated if the abnormal condition is cleared. FAULTB pin will be pulled low if LED open condition happens, and will resume high if LED open condition is removed. The comparator in LED open protection has a typical deglitch time of 20 μ s to avoid wrong trigger, therefore the LED open protection is invalid when the PWM on time is shorter than 20 μ s during PWM dimming.

LED Short Protection

The AL5873Q detects the LED short status by monitoring voltage at the LEDx pins. When the LED string anode is short to cathode, V_{LEDX} will be pulled up to nearly V_{IN} . And if the voltage gap ($V_{IN} - V_{LEDX}$) is less than 1V and lasts for a short time period, the AL5873Q enters protection and shuts down all channels. The time period is 7 cycles of the input PWM signal or 5ms timer when the PWM duty is 100%. The abnormal channel will be periodically rechecked every 128ms afterward to check if the abnormal condition is cleared. The LED driver will be re-activated if the abnormal condition is cleared. FAULTB pin will be pulled low if LED short condition happens, and will resume high if LED short condition is removed. The comparator in LED short protection has a typical deglitch time of 20 μ s to avoid wrong trigger, therefore the LED short protection is invalid when the PWM on time is shorter than 20 μ s during PWM dimming.

Fault Reporting

When the PWM is active, the AL5873Q detects and reports the FAULTB status upon the occurrence of OTP, LED Short, LED Open, and UVLO. The FAULTB pin is an open-drain output design with a current source pulled up. The FAULTB pin can be left floating or pulled up to a voltage (such as V_{IN}) through a resistor. When the FAULTB is floating, the voltage on the pin is clamped to a voltage (typical 3V) during normal operation. Besides a fault status indicator pin, this pin also behaves as an input pin. The voltage on FAULTB pin is connected to internal comparator and compared with a reference voltage (typical 1.5V). If the voltage on FAULTB pin is lower than the reference voltage, the output signal of the comparator will shut down all LED channels.

In case there is no MCU, one can connect up to 4 AL5873Q FAULTB pins together. When one or more devices have errors, the respective FAULTB pins go low, pulling the connected FAULTB bus down and shutting down all device outputs accordingly.

The device releases the FAULTB bus when external circuitry or internal current source pulls the FAULTB pin high, on toggling of the PWM pin, or on a power cycle of the device. In case there is no MCU, only a power cycle clears the fault.

Application and Implementation

For many automobiles, the same set of LEDs function as both tail lights and stop lights. Thus, the LEDs must operate at two different brightness levels. The AL5873Q can be used in stop/tail applications where the LED current is switched between a high current (indicating stop or brake) and a low current (for normal tail light operation). Figure 7 illustrates the recommended way to configure the AL5873Q for stop/tail applications, and the R_{PWM} and R_{FULL} with 10kΩ or larger one are recommended to reduce the influence of power supply variation.

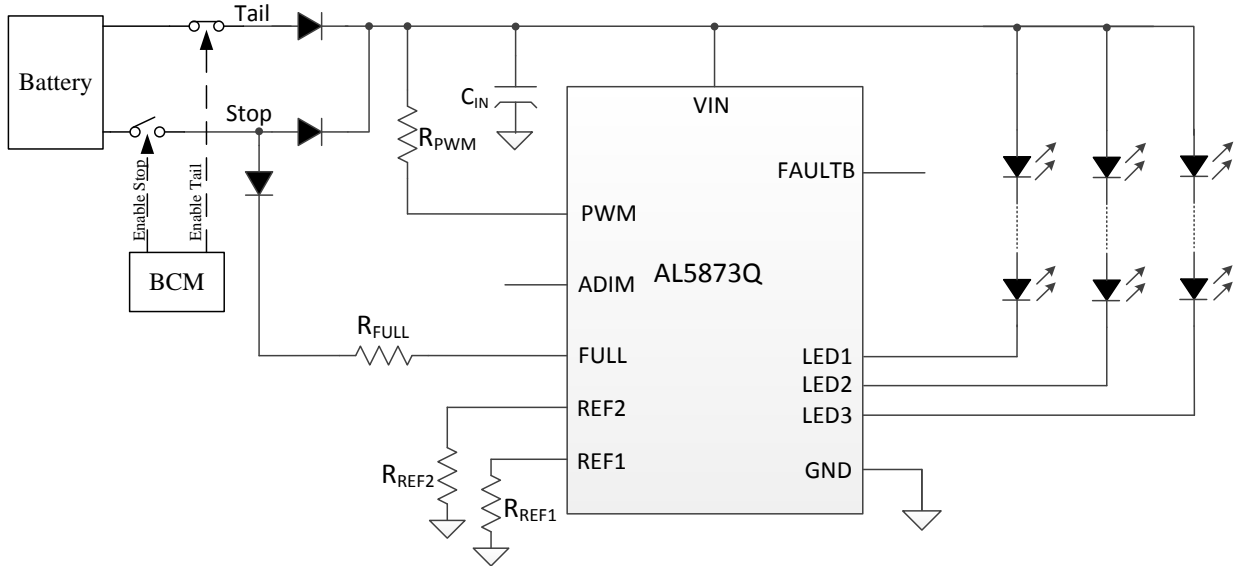
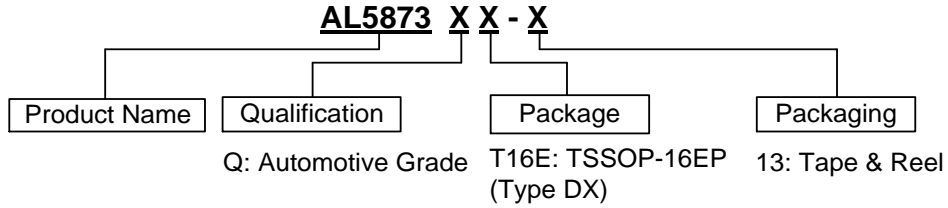

Figure 7. Stop/Tail Light Application Circuit through FULL pin

The stop light LED current per channel is set by R_{REF2} , and the tail light LED current is set by R_{REF1} . When the LED lamps work as stop light, the FULL is pulled high and higher LED current is set by R_{REF2} . When the LED lamps work as tail light, the FULL is pulled low and lower LED current is set by R_{REF1} .

Ordering Information



Part Number	Package Code	Packaging	13" Tape and Reel	
			Quantity	Part Number Suffix
AL5873QT16E-13	T16E	TSSOP-16EP(Type DX) (Note 8)	2,500/Tape & Reel	-13

Note: 8. For packaging details, go to our website at <http://www.diodes.com/products/packages.htm>

Marking Information

Package Type: TSSOP-16EP (Type DX)

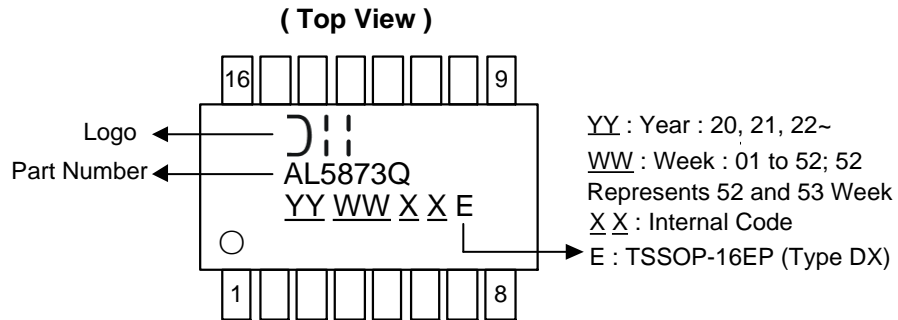

Package Outline Dimensions

Please see <http://www.diodes.com/package-outlines.html> for the latest version.

(1) Package type: TSSOP-16EP (Type DX)

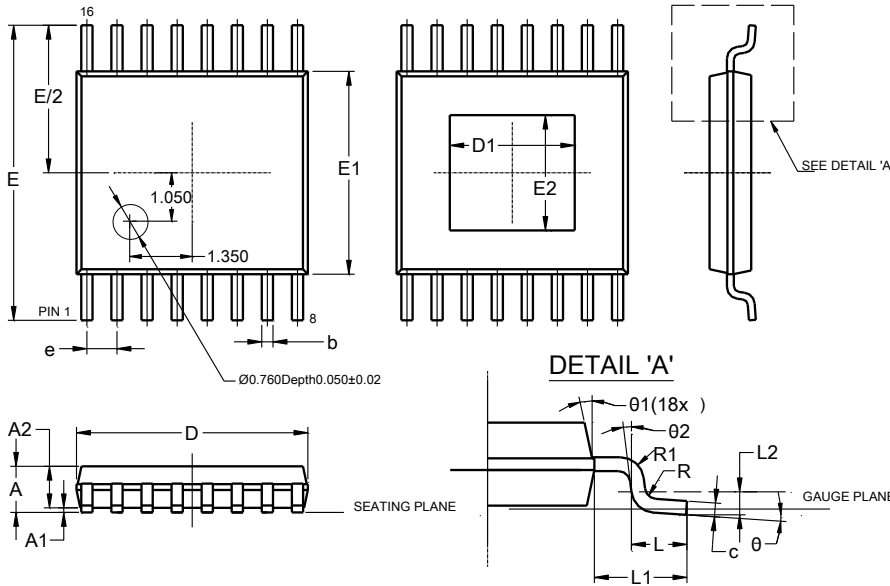

TSSOP-16EP (Type DX)			
Dim	Min	Max	Typ
A	--	1.08	--
A1	0.05	0.15	--
A2	0.80	0.93	--
b	0.19	0.30	--
c	0.09	0.20	--
D	4.90	5.10	--
D1	2.70	--	--
E	6.40 BSC		
E1	4.30	4.50	--
E2	2.50	--	--
e	0.65 BSC		
L	0.45	0.75	--
L1	1.00 REF		
L2	0.25 BSC		
R	0.09	--	--
R1	0.09	--	--
θ	0°	8°	--
θ1	5°	15°	--
θ2	0°	--	--
All Dimensions in mm			

Suggested Pad Layout

Please see <http://www.diodes.com/package-outlines.html> for the latest version.

(1) Package type: TSSOP-16EP (Type DX)

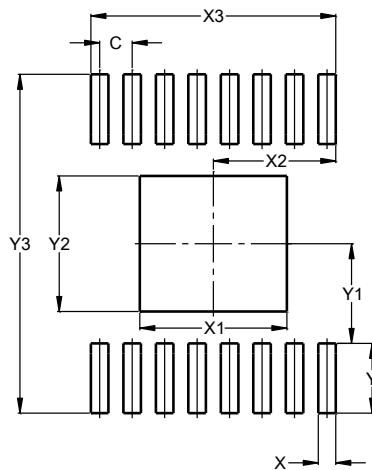

Dimensions	Value (in mm)
C	0.65
X	0.35
X1	2.94
X2	2.45
X3	4.90
Y	1.40
Y1	2.00
Y2	2.72
Y3	6.80

Mechanical Data

- Moisture Sensitivity: MSL Level 1 per J-STD-020
- Terminals: Finish – Matte Tin Plated Leads, Solderable per JESD22-B102 ③
- Weight: 0.055 grams (Approximate)

IMPORTANT NOTICE

1. DIODES INCORPORATED AND ITS SUBSIDIARIES ("DIODES") MAKE NO WARRANTY OF ANY KIND, EXPRESS OR IMPLIED, WITH REGARDS TO ANY INFORMATION CONTAINED IN THIS DOCUMENT, INCLUDING, BUT NOT LIMITED TO, THE IMPLIED WARRANTIES OF MERCHANTABILITY, FITNESS FOR A PARTICULAR PURPOSE OR NON-INFRINGEMENT OF THIRD PARTY INTELLECTUAL PROPERTY RIGHTS (AND THEIR EQUIVALENTS UNDER THE LAWS OF ANY JURISDICTION).
2. The Information contained herein is for informational purpose only and is provided only to illustrate the operation of Diodes products described herein and application examples. Diodes does not assume any liability arising out of the application or use of this document or any product described herein. This document is intended for skilled and technically trained engineering customers and users who design with Diodes products. Diodes products may be used to facilitate safety-related applications; however, in all instances customers and users are responsible for (a) selecting the appropriate Diodes products for their applications, (b) evaluating the suitability of the Diodes products for their intended applications, (c) ensuring their applications, which incorporate Diodes products, comply the applicable legal and regulatory requirements as well as safety and functional-safety related standards, and (d) ensuring they design with appropriate safeguards (including testing, validation, quality control techniques, redundancy, malfunction prevention, and appropriate treatment for aging degradation) to minimize the risks associated with their applications.
3. Diodes assumes no liability for any application-related information, support, assistance or feedback that may be provided by Diodes from time to time. Any customer or user of this document or products described herein will assume all risks and liabilities associated with such use, and will hold Diodes and all companies whose products are represented herein or on Diodes' websites, harmless against all damages and liabilities.
4. Products described herein may be covered by one or more United States, international or foreign patents and pending patent applications. Product names and markings noted herein may also be covered by one or more United States, international or foreign trademarks and trademark applications. Diodes does not convey any license under any of its intellectual property rights or the rights of any third parties (including third parties whose products and services may be described in this document or on Diodes' website) under this document.
5. Diodes products are provided subject to Diodes' Standard Terms and Conditions of Sale (<https://www.diodes.com/about/company/terms-and-conditions/terms-and-conditions-of-sales/>) or other applicable terms. This document does not alter or expand the applicable warranties provided by Diodes. Diodes does not warrant or accept any liability whatsoever in respect of any products purchased through unauthorized sales channel.
6. Diodes products and technology may not be used for or incorporated into any products or systems whose manufacture, use or sale is prohibited under any applicable laws and regulations. Should customers or users use Diodes products in contravention of any applicable laws or regulations, or for any unintended or unauthorized application, customers and users will (a) be solely responsible for any damages, losses or penalties arising in connection therewith or as a result thereof, and (b) indemnify and hold Diodes and its representatives and agents harmless against any and all claims, damages, expenses, and attorney fees arising out of, directly or indirectly, any claim relating to any noncompliance with the applicable laws and regulations, as well as any unintended or unauthorized application.
7. While efforts have been made to ensure the information contained in this document is accurate, complete and current, it may contain technical inaccuracies, omissions and typographical errors. Diodes does not warrant that information contained in this document is error-free and Diodes is under no obligation to update or otherwise correct this information. Notwithstanding the foregoing, Diodes reserves the right to make modifications, enhancements, improvements, corrections or other changes without further notice to this document and any product described herein. This document is written in English but may be translated into multiple languages for reference. Only the English version of this document is the final and determinative format released by Diodes.
8. Any unauthorized copying, modification, distribution, transmission, display or other use of this document (or any portion hereof) is prohibited. Diodes assumes no responsibility for any losses incurred by the customers or users or any third parties arising from any such unauthorized use.

Copyright © 2021 Diodes Incorporated

www.diodes.com