

300 mA, 42 V Voltage Regulator with High Noise Immunity

No. EA-527-201014

OVERVIEW

The R1526x is a voltage regulator featuring 300mA output current and 42 V maximum input voltage. Since this device has excellent noise immunity to external electromagnetic interference, it is suitable for use in environments where electromagnetic waves may cause malfunctions.

KEY BENEFITS

- Excellent noise immunity. Refer to *Noise Immunity Test* in Typical Characteristics.
- Pin configuration considering functional safety

KEY SPECIFICATIONS

- Input Voltage Range (Maximum Rating):
3.5 V to 42 V (50 V)
- Operating temperature range: -40°C to 105°C
- Standby Current: Typ. 0.1 μ A
- Dropout Voltage: Max. 0.5 V ($I_{OUT} = 200$ mA, $V_{OUT} = 5.0$ V)
- Output Voltage: 1.8 V to 9.0 V (in 0.1 V step)
- Output Voltage Accuracy: ± 0.6 % ($T_a = 25^\circ\text{C}$)
 ± 1.6 % ($-40^\circ\text{C} \leq T_a \leq 105^\circ\text{C}$)
- Line Regulation: Typ. 0.01%/V ($V_{SET} + 1$ V $\leq V_{IN} \leq 42$ V)
- Short-circuit Protection: Limit at Typ. 100 mA
- Overcurrent Protection: Limit at Typ. 450 mA
- Thermal Shutdown: Detection Temperature. Typ. 160°C
- Output capacitor: $C_{OUT} \geq 10$ μ F
- Ripple Rejection: Typ. 50 dB ($f = 100$ Hz)

TYPICAL CHARACTERISTICS

Noise Immunity Test

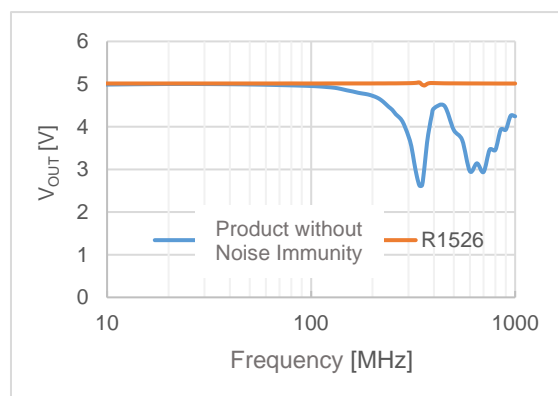

DPI method

PACKAGE

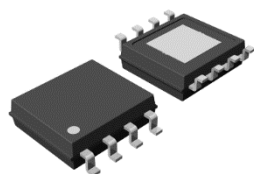

HSOP-8E
5.2 x 6.2 x 1.45 mm

TYPICAL APPLICATION

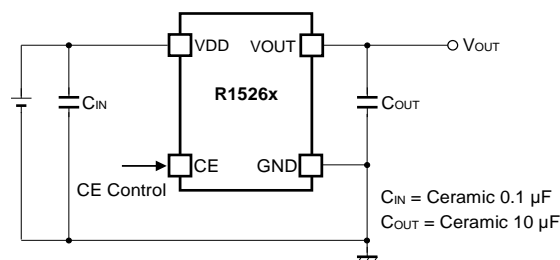

APPLICATIONS

- Power source for home appliances such as refrigerators, rice cookers and electric hot-water pots.
- Power source for notebook PCs, digital TVs, cordless phones, and private LAN systems.
- Power source for office equipment machines such as copiers, printers, facsimiles, scanners and projectors.

SELECTION GUIDE

The set output voltage is user-selectable.

Selection Guide

Product Name	Package	Quantity per Reel	Pb Free	Halogen Free
R1526Sxx1B-E2-FE	HSOP-8E	1,000 pcs	Yes	Yes

xx: Specify the set output voltage (V_{SET})

1.8 V (18) to 9.0 V (90) in 0.1 V step

Refer to *Product-specific Electrical Characteristics* for details.

BLOCK DIAGRAM

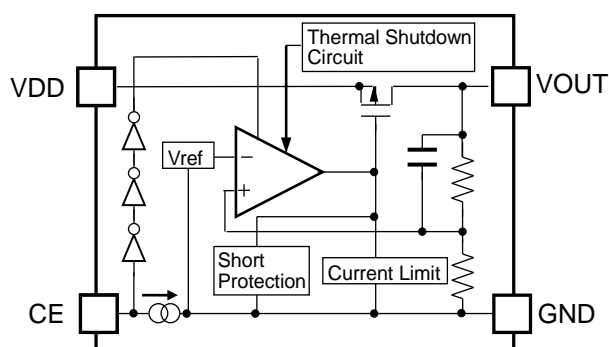

R1526x Block Diagram

PIN DESCRIPTIONS

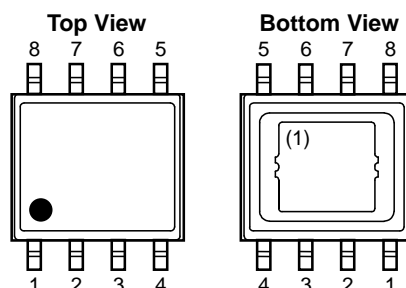

HSOP-8E Pin Configuration

HSOP-8E Pin Descriptions

Pin No.	Pin Name	Description
1	VOUT	Output Pin
2	NC ⁽²⁾	No Connection
3	NC ⁽²⁾	No Connection
4	CE	Chip Enable Pin (Active-high)
5	GND ⁽³⁾	Ground Pin
6	GND ⁽³⁾	Ground Pin
7	NC ⁽²⁾	No Connection
8	VDD	Input Pin

Pin Equivalent Circuit Diagrams

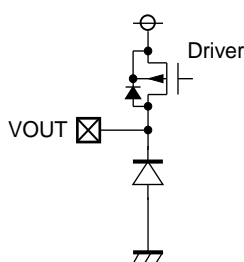

VOUT Pin Equivalent Circuit Diagram

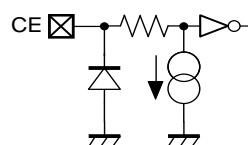

CE Pin Equivalent Circuit Diagram

⁽¹⁾ The tab on the bottom of the package is substrate level (GND). The tab must be connected to the ground plane on the board.

⁽²⁾ NC pin should be set to "Open".

⁽³⁾ GND pins should be connected together when mounted on a board.

ABSOLUTE MAXIMUM RATINGS

Absolute Maximum Ratings

Symbol	Parameter	Rating	Unit
V_{IN}	VIN Pin Input Voltage	-0.3 to 50	V
V_{IN}	VIN Pin Peak Voltage ⁽¹⁾	60	V
V_{CE}	CE Pin Input Voltage	-0.3 to 50	V
V_{CE}	CE Pin Peak Voltage ⁽¹⁾	60	V
V_{OUT}	VOUT Pin Voltage	-0.3 to $V_{IN} + 0.3 \leq 50$	V
I_{OUT}	Output Current	500	mA
P_D	Power Dissipation	Refer to Appendix "Power Dissipation"	
T_j	Junction Temperature Range	-40 to 125	°C
T_{stg}	Storage Temperature Range	-55 to 125	°C

ABSOLUTE MAXIMUM RATINGS

Electronic and mechanical stress momentarily exceeded absolute maximum ratings may cause permanent damage and may degrade the lifetime and safety for both device and system using the device in the field. The functional operation at or over these absolute maximum ratings is not assured.

RECOMMENDED OPERATING CONDITIONS

Recommended Operating Conditions

Symbol	Parameter	Rating	Unit
V_{IN}	Operating Input Voltage	3.5 to 42	V
T_a	Operating Temperature Range	-40 to 105	°C

RECOMMENDED OPERATING CONDITIONS

All of electronic equipment should be designed that the mounted semiconductor devices operate within the recommended operating conditions. The semiconductor devices cannot operate normally over the recommended operating conditions, even if they are used over such conditions by momentary electronic noise or surge. And the semiconductor devices may receive serious damage when they continue to operate over the recommended operating conditions.

⁽¹⁾ Duration time: within 200 ms

ELECTRICAL CHARACTERISTICS

$V_{IN} = 14\text{ V}$, $V_{CE} = V_{IN}$, unless otherwise specified.

The specifications surrounded by are guaranteed by design engineering at $-40^{\circ}\text{C} \leq T_a \leq 105^{\circ}\text{C}$.

R1526x-FE Electrical Characteristics

($T_a = 25^{\circ}\text{C}$)

Symbol	Parameter	Conditions	Min.	Typ.	Max.	Unit	
I_{SS}	Supply Current	$V_{IN} = 14\text{ V}$, $I_{OUT} = 0\text{ mA}$		32	55	μA	
$I_{standby}$	Standby Current	$V_{IN} = 42\text{ V}$, $V_{CE} = 0\text{ V}$		0.1	2.0	μA	
V_{OUT}	Output Voltage	$8\text{ V}^{(1)} \leq V_{IN} \leq 16\text{ V}$, $I_{OUT} = 1\text{ mA}$	$T_a = 25^{\circ}\text{C}$	$\times 0.994$	$\times 1.006$	V	
			$-40^{\circ}\text{C} \leq T_a \leq 105^{\circ}\text{C}$	$\times 0.984$	$\times 1.016$		
$\Delta V_{OUT} / \Delta I_{OUT}$	Load Regulation ⁽²⁾	$V_{IN} = V_{SET} + 2.0\text{ V}$, $1\text{ mA} \leq I_{OUT} \leq 100\text{ mA}$	$1.8\text{ V} \leq V_{SET} \leq 2.8\text{ V}$	-5		45	mV
			$2.8\text{ V} < V_{SET} \leq 5.4\text{ V}$	-5		40	
			$5.4\text{ V} < V_{SET} \leq 9.0\text{ V}$	-5		72	
		$V_{IN} = V_{SET} + 2.0\text{ V}$, $1\text{ mA} \leq I_{OUT} \leq 300\text{ mA}$	$1.8\text{ V} \leq V_{SET} \leq 2.8\text{ V}$	-5		68	
			$2.8\text{ V} < V_{SET} \leq 5.4\text{ V}$	-5		60	
			$5.4\text{ V} < V_{SET} \leq 9.0\text{ V}$	-5		108	
$\Delta V_{OUT} / \Delta V_{IN}$	Line Regulation ⁽³⁾	$V_{SET} + 1\text{V}^{(4)} \leq V_{IN} \leq 42\text{ V}$, $I_{OUT} = 1\text{ mA}$	$1.8\text{ V} \leq V_{SET} \leq 2.8\text{ V}$	-30		30	mV
			$2.8\text{ V} < V_{SET} \leq 9.0\text{ V}$	-0.02		0.02	%/V
V_{DIF}	Dropout Voltage ⁽⁵⁾	$I_{OUT} = 300\text{ mA}$	$1.8\text{ V} \leq V_{SET} \leq 2.4\text{ V}$		1.73	1.76	V
			$2.4\text{ V} < V_{SET} \leq 2.8\text{ V}$		0.75	1.35	
			$2.8\text{ V} < V_{SET} \leq 5.0\text{ V}$		0.71	1.23	
			$5.0\text{ V} < V_{SET} \leq 8.0\text{ V}$		0.40	0.74	
			$8.0\text{ V} < V_{SET} \leq 9.0\text{ V}$		0.35	0.65	
I_{LIM}	Output Current Limit	$V_{IN} = V_{SET} + 3.0\text{ V}$	300	450		mA	
I_{SC}	Short-circuit Current	$V_{IN} = 3.5\text{ V}$, $V_{OUT} = 0\text{ V}$		100		mA	
V_{CEH}	CE Pin Input Voltage, High		2.0		42	V	
V_{CEL}	CE Pin Input Voltage, Low	$V_{IN} = 42\text{ V}$			1.0	V	
I_{PD}	CE Pull-down Current	$V_{IN} = 42\text{ V}$, $V_{CE} = 2\text{ V}$		0.2	0.6	μA	

All parameters are tested under the pulse load condition ($T_j \approx T_a = 25^{\circ}\text{C}$).

⁽¹⁾ When $V_{SET} > 7\text{ V}$, $V_{IN} = V_{SET} + 1\text{ V}$

⁽²⁾ Output voltage change amount when $1\text{ mA} \leq I_{OUT} \leq 100\text{ mA}$ and $1\text{ mA} \leq I_{OUT} \leq 300\text{ mA}$,

$$\Delta V_{OUT} / \Delta I_{OUT} = V_{OUT} (@ I_{OUT} = 100\text{ mA}) - V_{OUT} (@ I_{OUT} = 1\text{ mA}) \text{ or}$$

$$\Delta V_{OUT} / \Delta I_{OUT} = V_{OUT} (@ I_{OUT} = 300\text{ mA}) - V_{OUT} (@ I_{OUT} = 1\text{ mA})$$

⁽³⁾ Output voltage change amount when $V_{SET} + 1\text{V} \leq V_{IN} \leq 42\text{ V}$,

$$\text{in case } V_{SET} \leq 2.8\text{ V}, \Delta V_{OUT} / \Delta V_{IN} = V_{OUT} (@ V_{IN} = 42\text{ V}) - V_{OUT} (@ V_{IN} = V_{SET} + 1\text{ V}) \text{ or}$$

$$\text{in case } V_{SET} > 2.8\text{ V}, \Delta V_{OUT} / \Delta V_{IN} = (V_{OUT} (@ V_{IN} = 42\text{ V}) - V_{OUT} (@ V_{IN} = V_{SET} + 1\text{ V})) / (42 - (V_{SET} + 1)) / V_{SET} \times 100$$

⁽⁴⁾ When $V_{SET} \leq 2.5\text{ V}$, $V_{IN} = 3.5\text{ V}$.

⁽⁵⁾ Dropout voltage is defined as the minimum value of the difference between the input and output voltages in order to supply a regulated output voltage with the specified load current.

The specifications surrounded by \square are guaranteed by design engineering at $-40^{\circ}\text{C} \leq T_a \leq 105^{\circ}\text{C}$.

R1526x (-FE) Product-specific Electrical Characteristics

(Ta = 25°C)

Product name	V _{OUT} (V) (Ta = 25°C)			V _{OUT} (V) (-40°C ≤ Ta ≤ 105°C)			V _{DIF} (V)	
	MIN.	TYP.	MAX.	MIN.	TYP.	MAX.	TYP.	MAX.
R1526x018x	1.7892	1.80	1.8108	\square 1.7712	1.80	\square 1.8288	1.73	\square 1.76
R1526x025x	2.4850	2.50	2.5150	\square 2.4600	2.50	\square 2.5400	0.75	\square 1.35
R1526x028x	2.7832	2.80	2.8168	\square 2.7552	2.80	\square 2.8448		
R1526x030x	2.9820	3.00	3.0180	\square 2.9520	3.00	\square 3.0480	0.71	\square 1.23
R1526x033x	3.2802	3.30	3.3198	\square 3.2472	3.30	\square 3.3528		
R1526x034x	3.3796	3.40	3.4204	\square 3.3456	3.40	\square 3.4544		
R1526x050x	4.9700	5.00	5.0300	\square 4.9200	5.00	\square 5.0800		
R1526x055x	5.4670	5.50	5.5330	\square 5.4120	5.50	\square 5.5880	0.40	\square 0.74
R1526x060x	5.9640	6.00	6.0360	\square 5.9040	6.00	\square 6.0960		
R1526x064x	6.3616	6.40	6.4384	\square 6.2976	6.40	\square 6.5024		
R1526x075x	7.4550	7.50	7.5450	\square 7.3800	7.50	\square 7.6200		
R1526x080x	7.9520	8.00	8.0480	\square 7.8720	8.00	\square 8.1280	0.35	\square 0.65
R1526x085x	8.4490	8.50	8.5510	\square 8.3640	8.50	\square 8.6360		
R1526x090x	8.9460	9.00	9.0540	\square 8.8560	9.00	\square 9.1440		

Product name	$\Delta V_{\text{OUT}}/\Delta I_{\text{OUT}}$ (mV) (1 mA ≤ I _{OUT} ≤ 100 mA)		$\Delta V_{\text{OUT}}/\Delta I_{\text{OUT}}$ (mV) (1 mA ≤ I _{OUT} ≤ 300 mA)		$\Delta V_{\text{OUT}}/\Delta V_{\text{IN}}$	
	MIN.	MAX.	MIN.	MAX.	MIN.	MAX.
R1526x018x	\square -5	\square 45	\square -5	\square 68	\square -30 (mV)	\square 30 (mV)
R1526x025x						
R1526x028x						
R1526x030x	\square -5	\square 40	\square -5	\square 60	\square -0.02 (%/V)	\square 0.02 (%/V)
R1526x033x						
R1526x034x						
R1526x050x						
R1526x055x	\square -5	\square 72	\square -5	\square 108	\square -0.02 (%/V)	\square 0.02 (%/V)
R1526x060x						
R1526x064x						
R1526x075x						
R1526x080x						
R1526x085x						
R1526x090x						

TYPICAL APPLICATION CIRCUIT

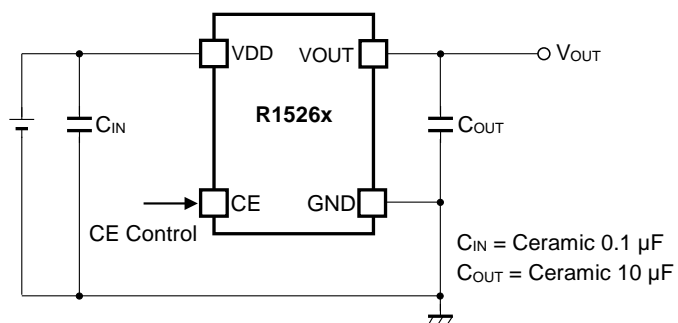

R1526x Typical Application Circuit

Component examples

Symbol	Capacitance	Tolerance	Voltage resistance	Temperature characteristics
C_{IN}	0.1 μF	$\pm 10\%$	50 V	X7R
C_{OUT}	10 μF	$\pm 10\%$	50 V	X7S

THEORY OF OPERATION

Thermal Shutdown Function

When the junction temperature exceeds the thermal shutdown detection temperature (Typ.160°C), R1526x goes into standby state and suppresses its self-heating. When the junction temperature falls below the thermal shutdown release temperature (Typ.135°C), this device becomes active.

Chip Enable Function

By inputting "High" and "Low" to the CE pin, R1526x can be set to active or standby state. The CE pin is pulled down with a constant current of Typ. 0.2 μ A inside the IC. If the chip enable function is not needed, connect the CE pin directly to the VDD pin. R1526x can apply a voltage to the CE pin even when no voltage is applied to VDD pin.

TECHNICAL NOTES

The performance of a power source circuit using this device is highly dependent on a peripheral circuit. A peripheral component or the device mounted on PCB should not exceed a rated voltage, a rated current or a rated power. When designing a peripheral circuit, please be fully aware of the following points.

Phase Compensation

R1526x uses the output capacitor capacitance and equivalent series resistance (ESR) for phase compensation, to secure stable operation even when the load current is varied. For this purpose, make sure to use an output capacitor (C_{OUT}) of 10 μ F or more as close as possible to the VOUT pin. Since the output may oscillate depending on the ESR, select a low ESR capacitor with reference to *the series equivalent resistance vs. output current* characteristics in the datasheet. In addition, Make the power supply and GND lines sufficient. Connect a capacitor (C_{IN}) of 0.1 μ F or more between the VDD pin and GND, and keep the wiring as short as possible.

Behavior below the minimum operating voltage

When $V_{SET} \leq 2.8$ V and the power supply voltage is below the recommended operating voltage, the output voltage may become unstable and exceed the set output voltage of LDO. To avoid this behavior at power-on, turn on the voltage of both VDD and CE pins at a slew rate of 35 V/ms or more when both pins are turned on at the same time. When turning on the VDD pin at a slew rate of 35 V/ms or less, change the CE pin from “Low” to “High” after the power supply voltage exceeds 3.5 V.

To avoid this behavior at power-off, turn off the voltage of both VDD and CE pins at a steeper slew rate than -35 V/ms when both pins are turned off at the same time.

When turning off the VDD pin at a slower slew rate than -35 V/ms, change the CE pin from “High” to “Low” before the power supply voltage falls below 3.5 V.

Thermal Shutdown Function

The thermal shutdown function prevents the IC from fuming and ignition but does not ensure the IC's reliability or keep the IC below the absolute maximum ratings. The thermal shutdown function does not operate on the heat generated by other than the normal IC operation such as latch-up and overvoltage application.

The thermal shutdown function operates in a state over the absolute maximum ratings, therefore the thermal shutdown function should not be used for a system design.

TYPICAL CHARACTERISTICS

Note: Typical Characteristics are intended to be used as reference data; they are not guaranteed.

1) Output Voltage vs. Output Current

C_{IN} = none, C_{OUT} = 10 μ F, T_a = 25°C

R1526x018

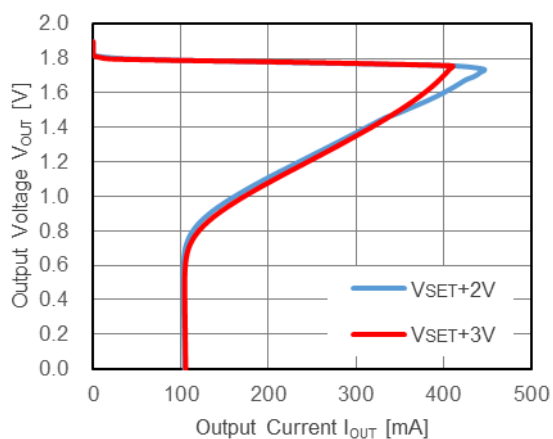

R1526x033

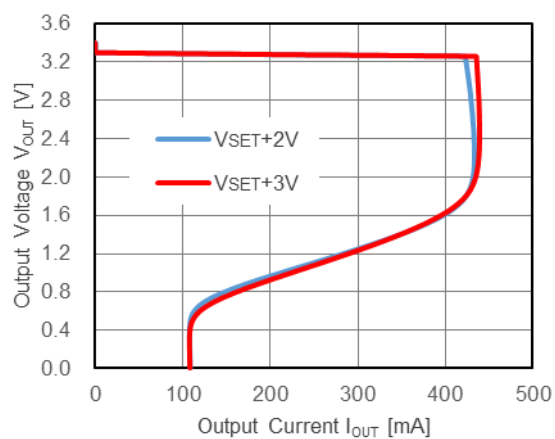

R1526x050

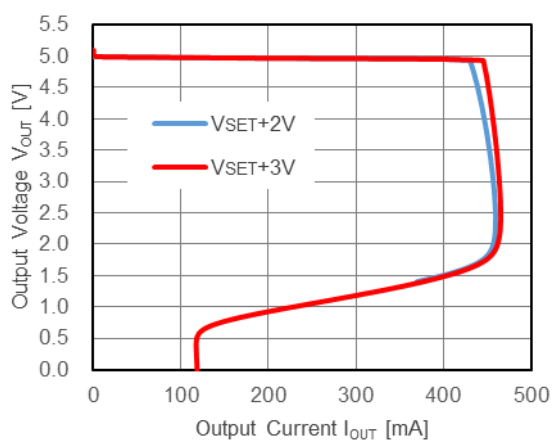

R1526x090

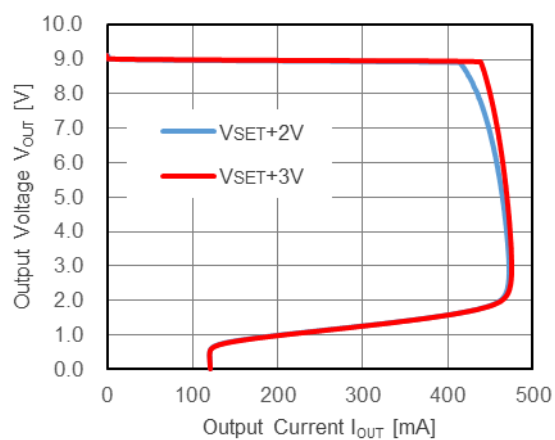

2) Output Voltage vs. Input Voltage

C_{IN} = none, C_{OUT} = 10 μ F, T_a = 25 $^{\circ}$ C

R1526x018

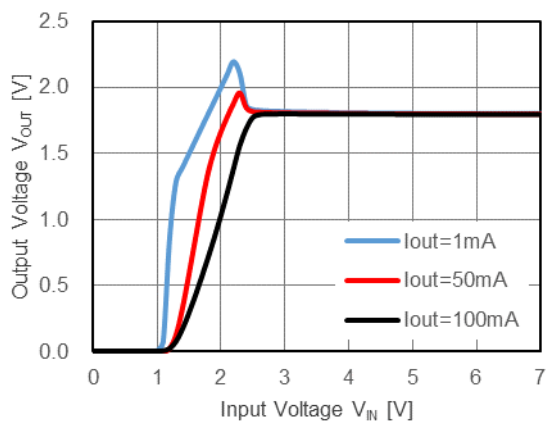

R1526x033

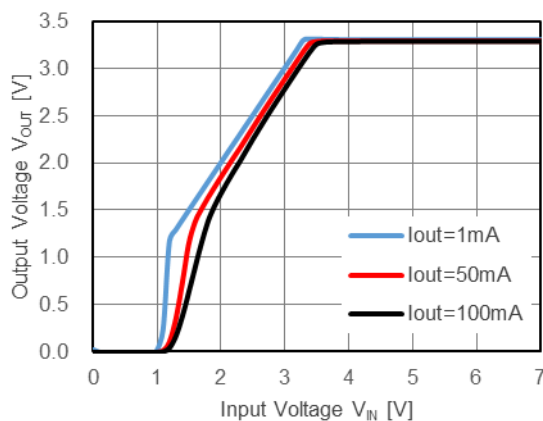

R1526x050

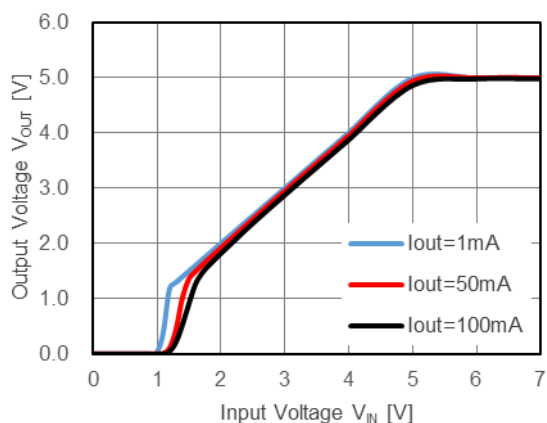

R1526x090

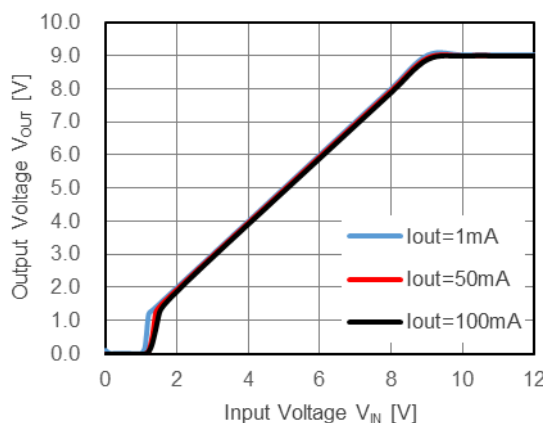

3) Output Voltage vs. Temperature

I_{OUT} = 1mA, C_{IN} = none, C_{OUT} = 10 μ F

R1526x018

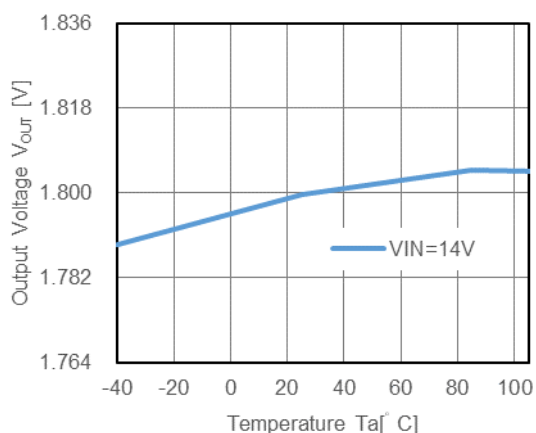

R1526x033

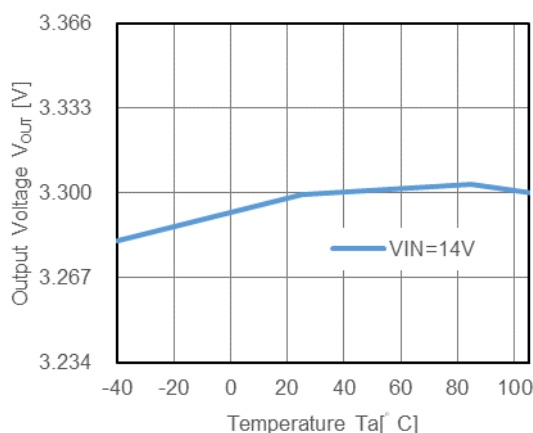

R1526x050

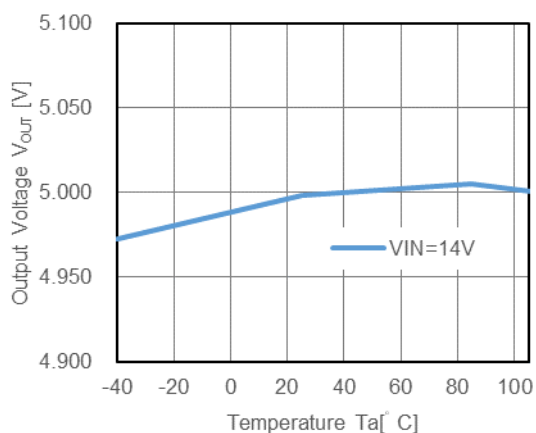

R1526x090

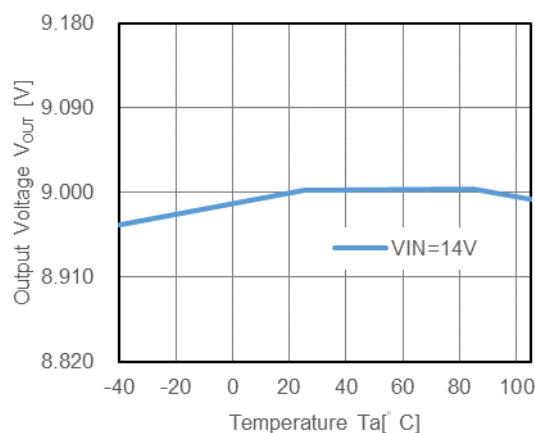

4) Supply Current vs. Input Voltage

C_{IN} = none, C_{OUT} = 10μF

R1526x018

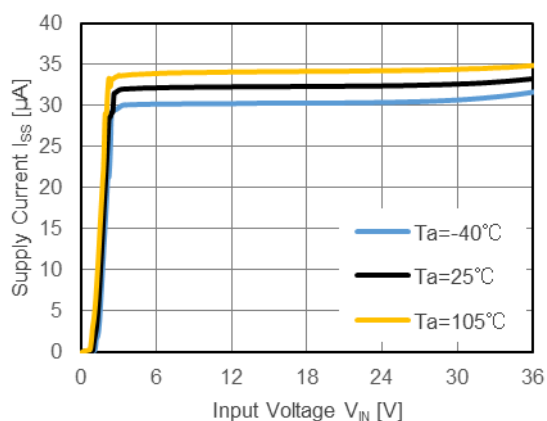

R1526x033

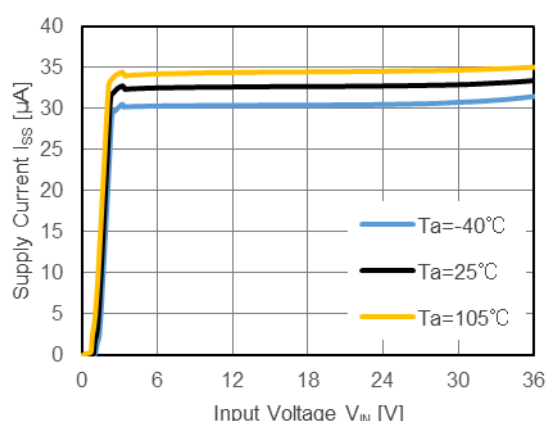

5) Supply Current vs. Temperature

C_{IN} = none, C_{OUT} = 10μF

R1526x018

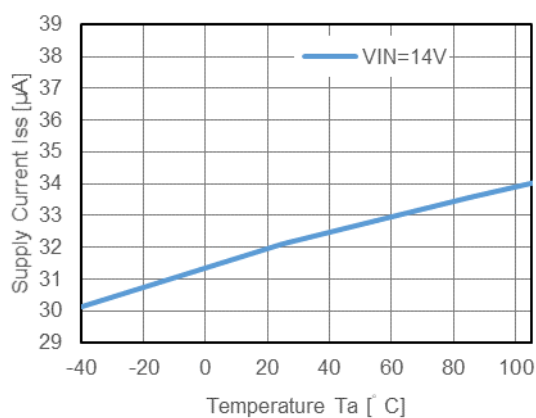

R1526x033

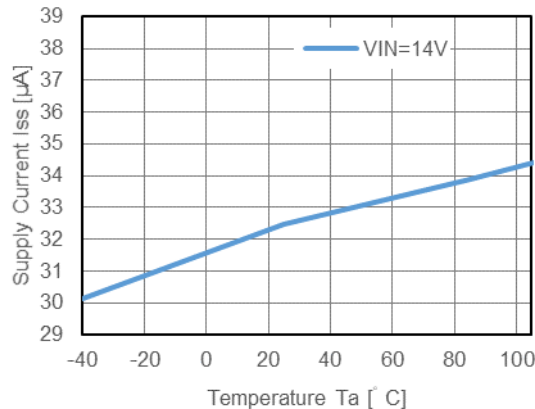

R1526x050

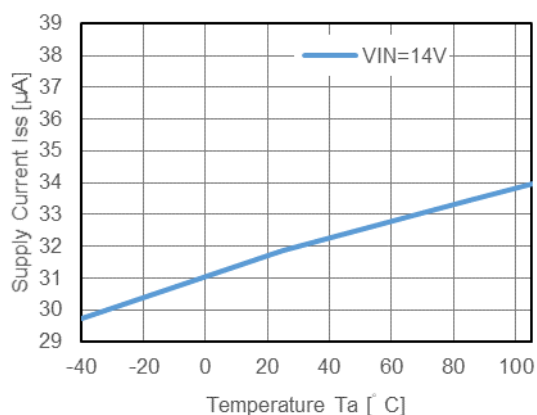

R1526x090

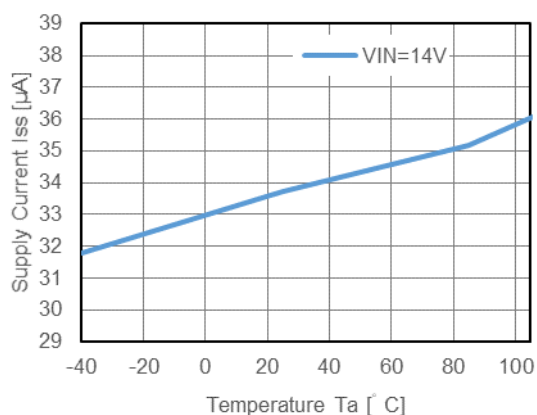

6) Dropout Voltage vs. Output Current

C_{IN} = none, C_{OUT} = 10μF

R1526x018

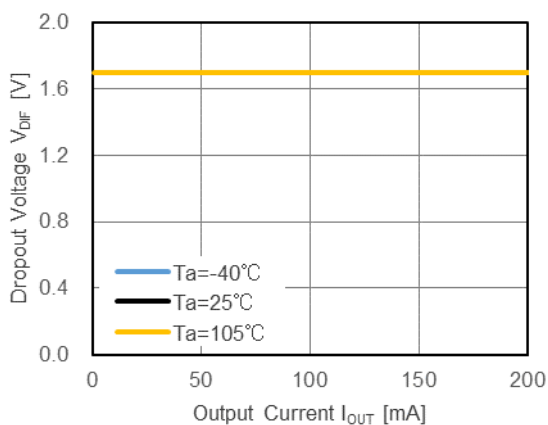

R1526x033

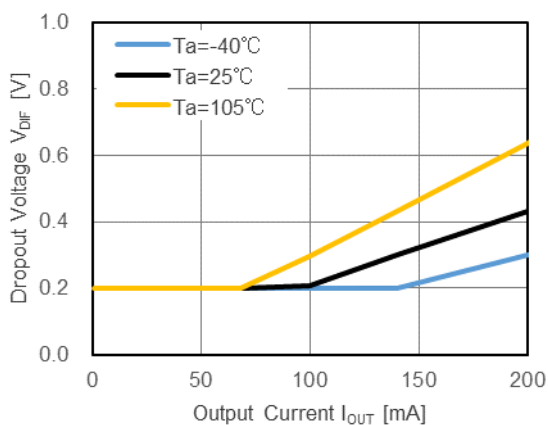

R1526x050

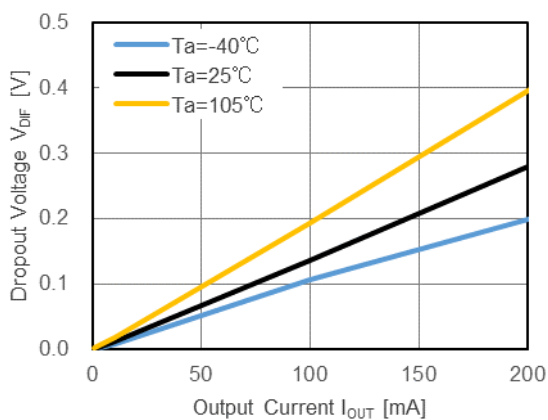

R1526x090

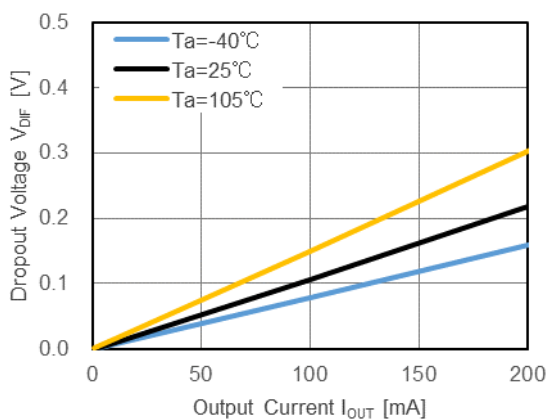

7) Dropout Voltage vs. Output Voltage

$C_{IN} = \text{none}$, $C = 10\mu\text{F}$, $T_a = 25^\circ\text{C}$

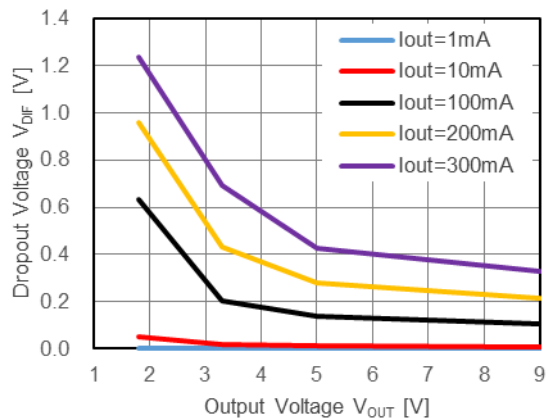

8) Ripple Rejection vs. Frequency

$V_{IN} = V_{SET}+2\text{V}$, Ripple = 0.2Vpp, $C_{IN} = \text{none}$, $C_{OUT} = 10\mu\text{F}$, $T_a = 25^\circ\text{C}$

R1526x018

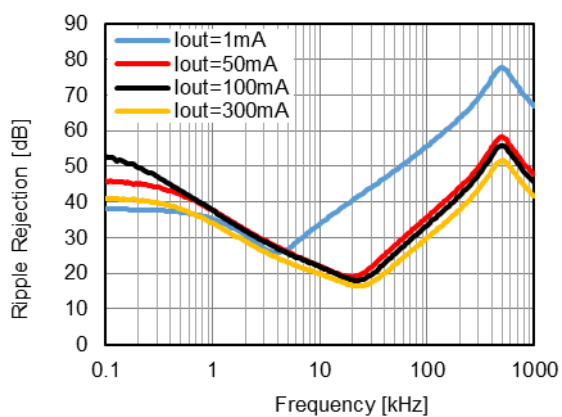

R1526x033

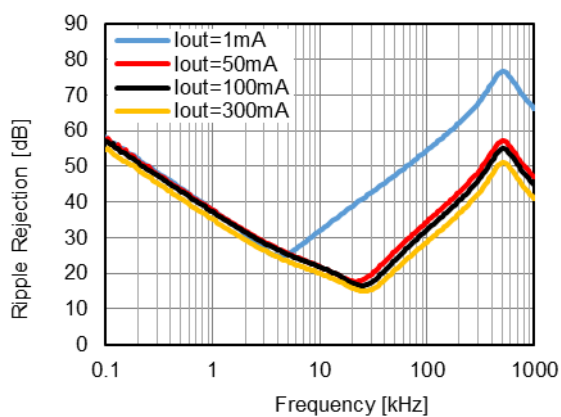

R1526x050

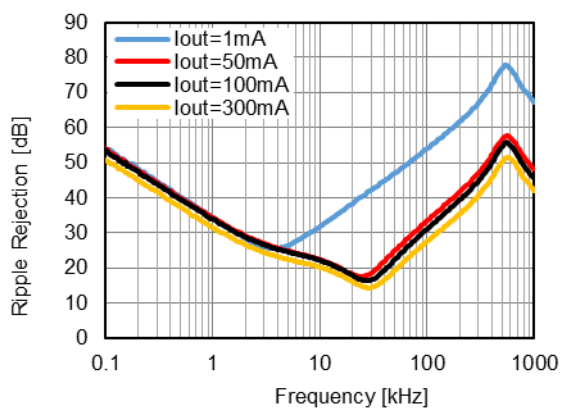

R1526x090

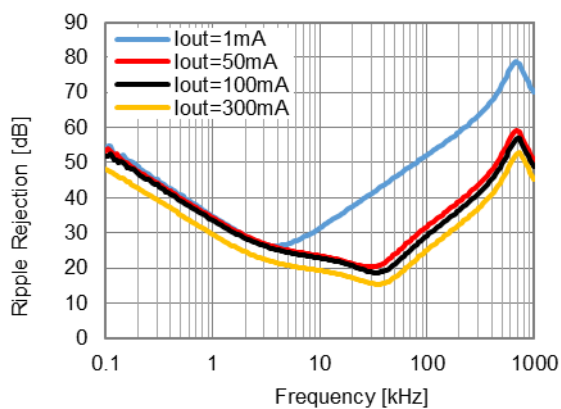

9) Ripple Rejection vs. Input Voltage

Ripple = 0.2Vpp, I_{OUT} = 50mA, C_{IN} = none, C_{OUT} = 10μF, Ta = 25°C

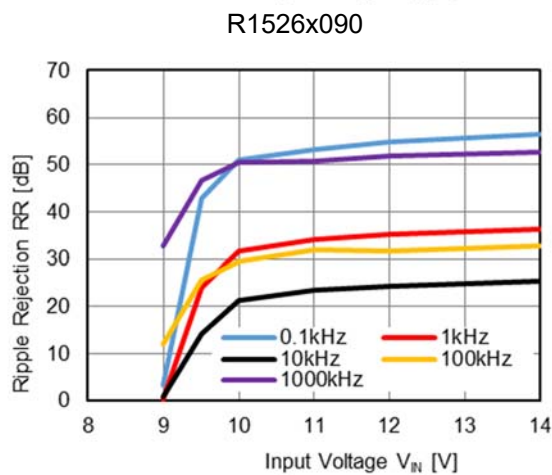
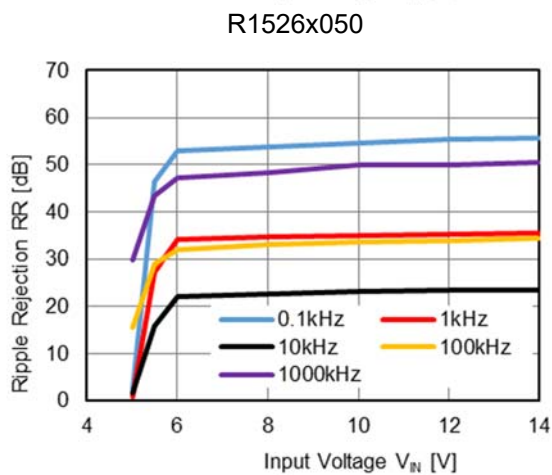
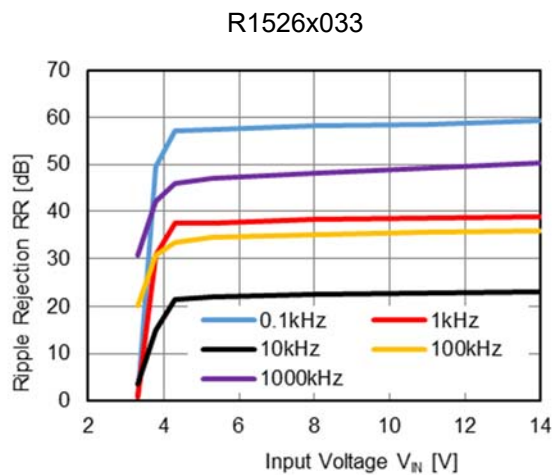
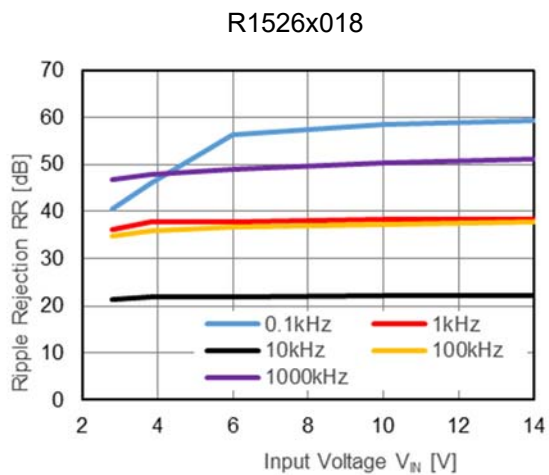

10) Input Transient Response

I_{OUT} = 1mA, C_{IN} = none, C_{OUT} = 10μF, Ta = 25°C, tr = tf = 1μs

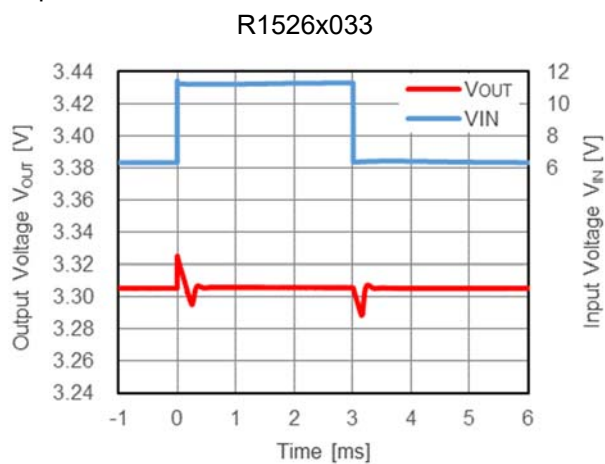
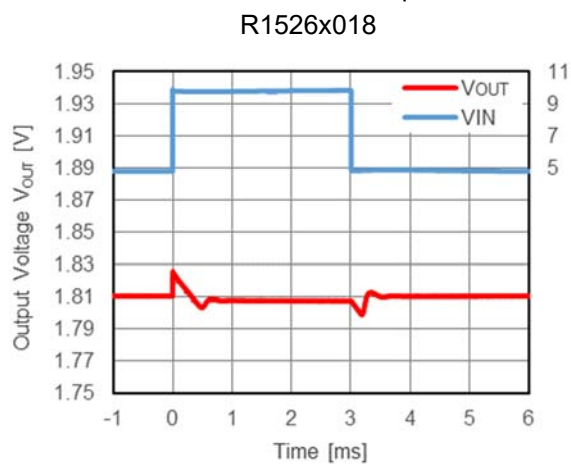

R1526x050

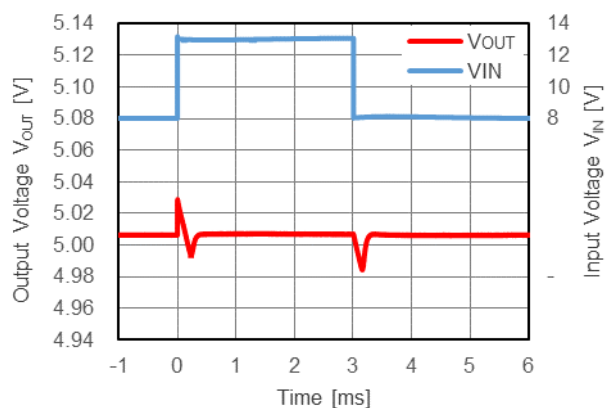

R1526x090

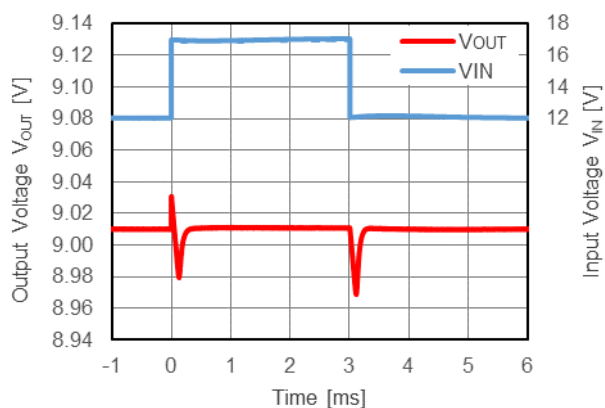

11) Load Transient Response

$V_{IN} = 14V$, $C_{IN} = 0.1\mu F$, $C_{OUT} = 10\mu F$, $T_a = 25^\circ C$, $t_r = t_f = 0.5\mu s$

R1526x018

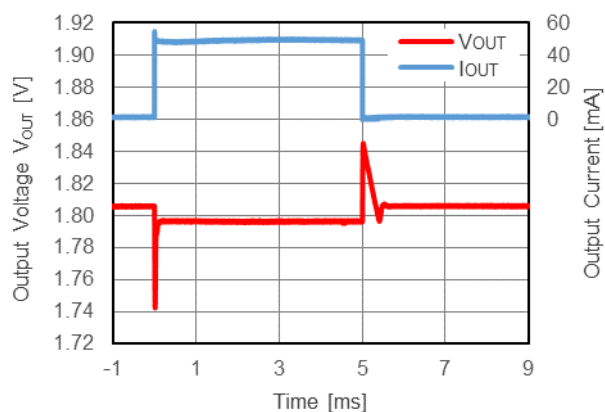

R1526x033

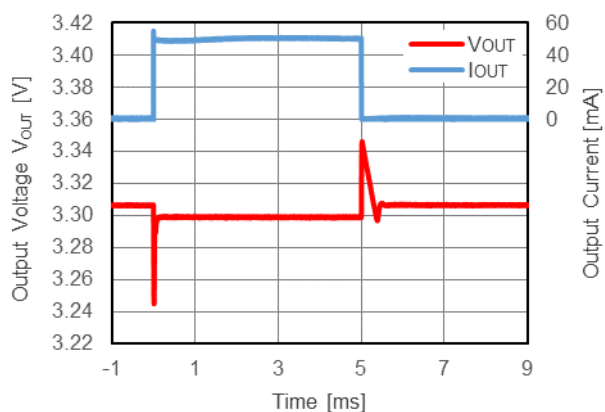

R1526x050

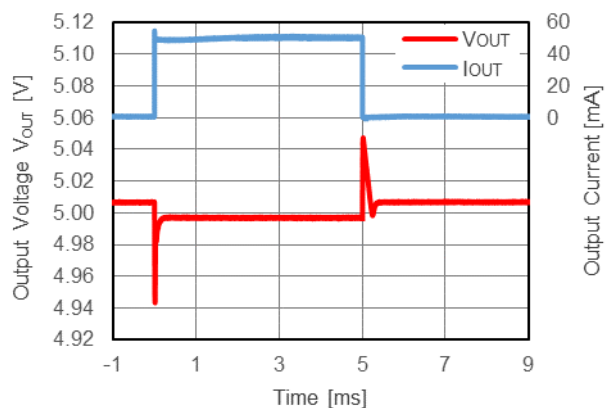

R1526x090

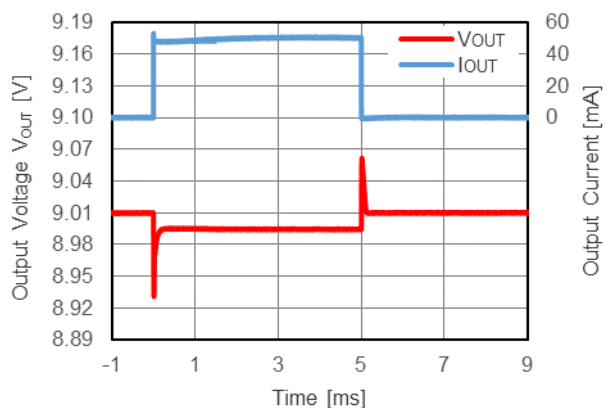

12) CE Transient Response

$V_{IN} = 14V, V_{CE} = 0V \rightarrow 14V, C_{IN} = 0.1\mu F, C_{OUT} = 10\mu F, T_a = 25^\circ C, t_r = t_f = 1\mu s$

R1526x018

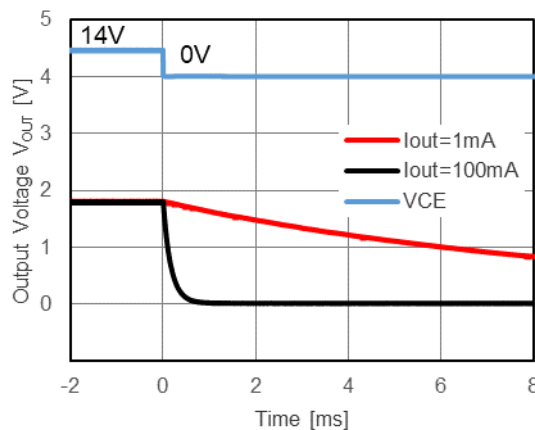
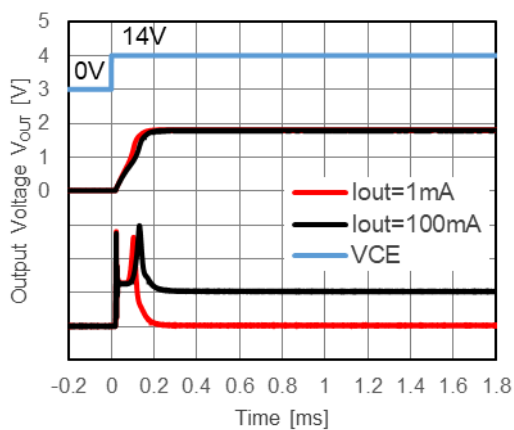

R1526x033

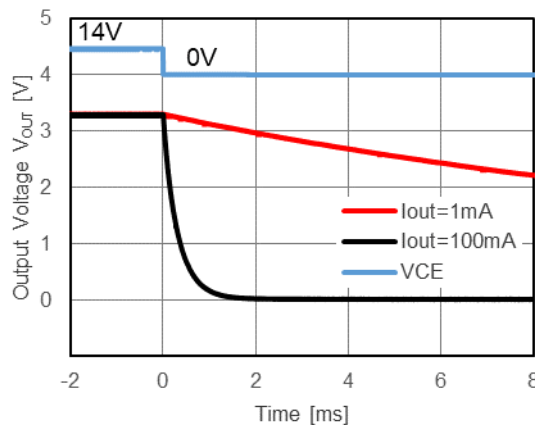
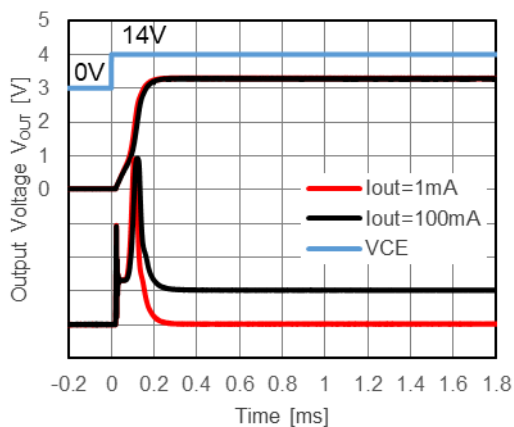

R1526x050

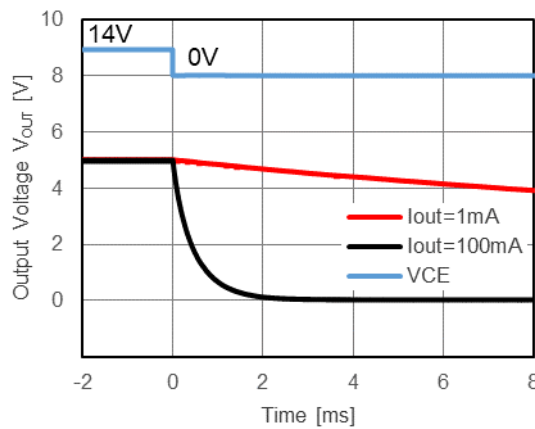
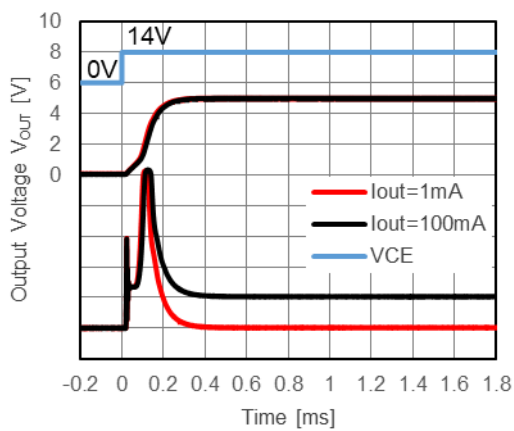

R1526x090

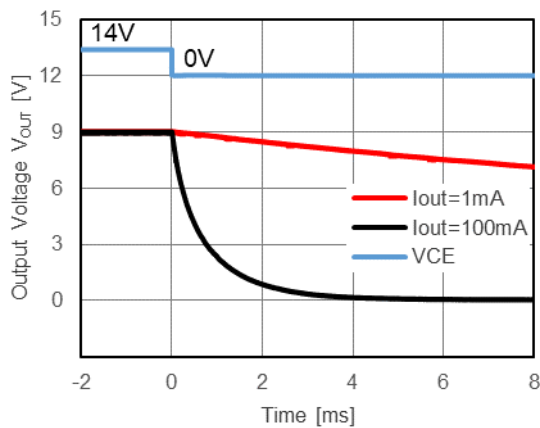
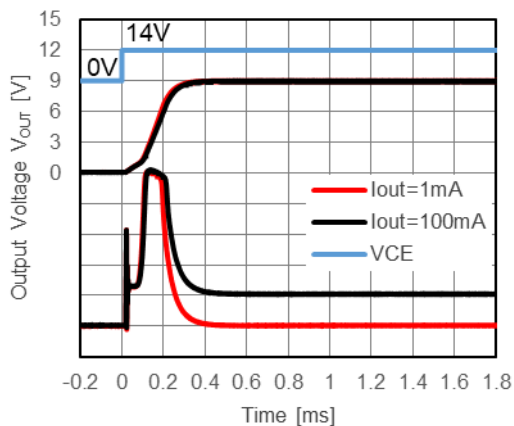

13) Power-on Transient Response

$I_{OUT} = 1\text{mA}$, $C_{IN} = \text{none}$, $C_{OUT} = 10\mu\text{F}$, $T_a = 25^\circ\text{C}$, $t_r = 1\mu\text{s}$

R1526x018

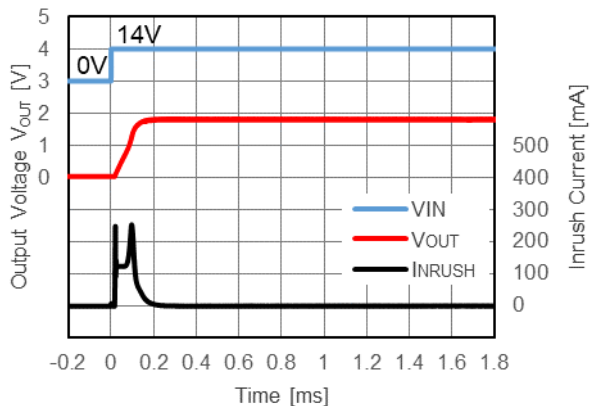

R1526x033

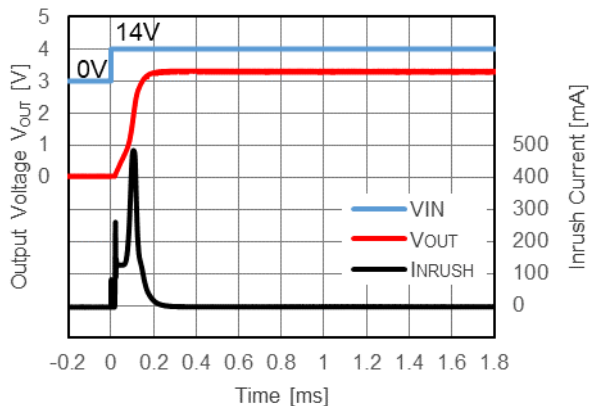

R1526x050

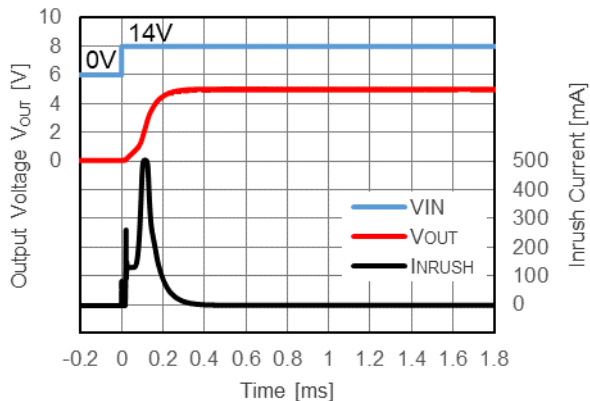

R1526x090

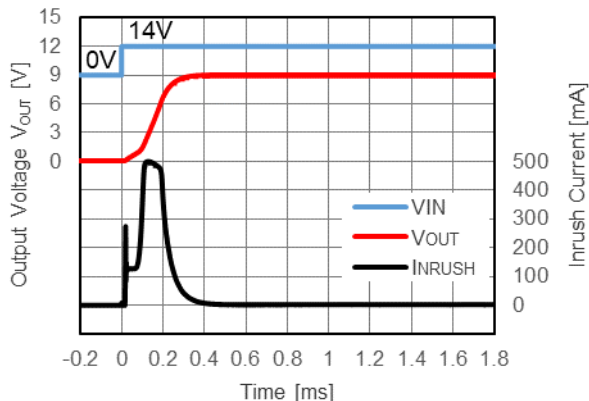

14) ESR (Equivalent Series Resistance)

$C_{IN} = 0.1\mu F$, $C_{OUT} = 10\mu F$, $T_a = -40^\circ C, 25^\circ C, 105^\circ C$

R1526x018

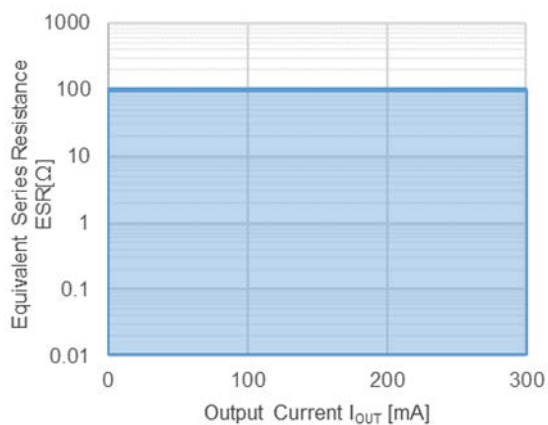

R1526x033

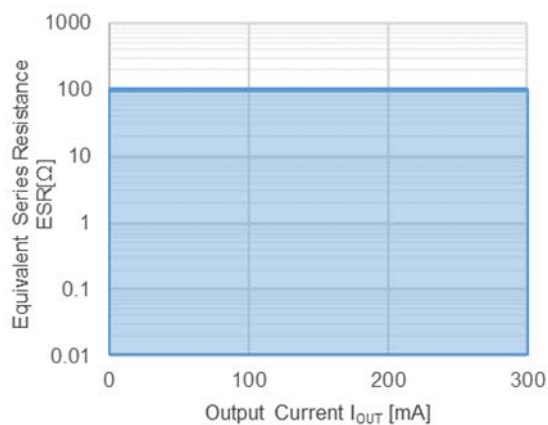

R1526x050

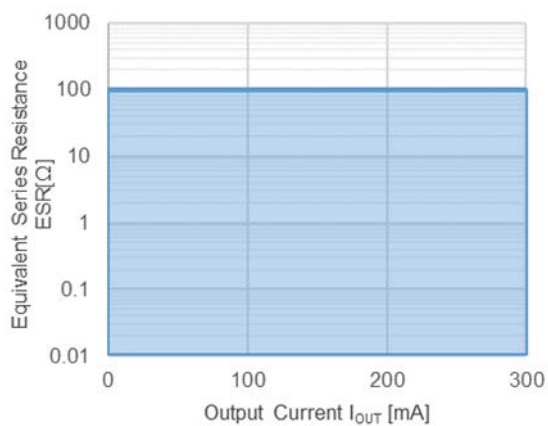

R1526x090

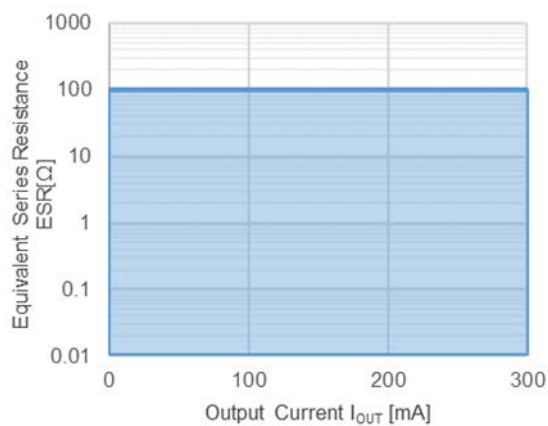

15) Noise Immunity

DPI method, $V_{IN} = 14V$, $V_{CE} = 3V$, $V_{OUT} = 1W$, $C_{IN} = C_{CE} = 0.1\mu F$, $C_{OUT} = 10\mu F$, $T_a = 25^\circ C$

R1526x033

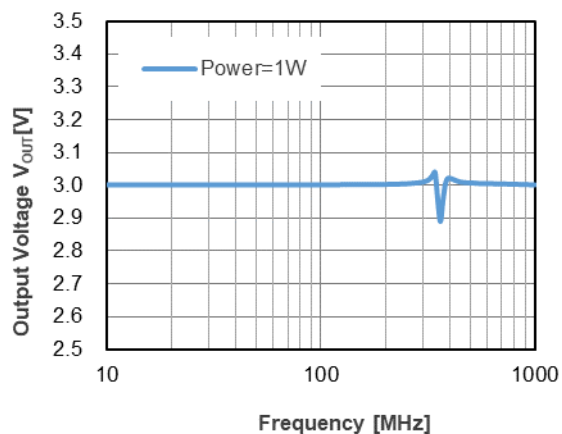

R1526x050

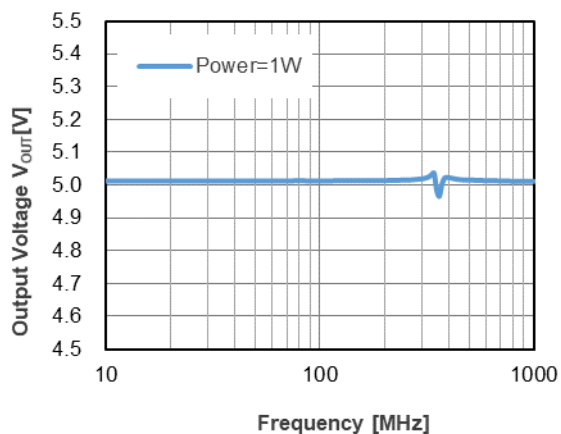

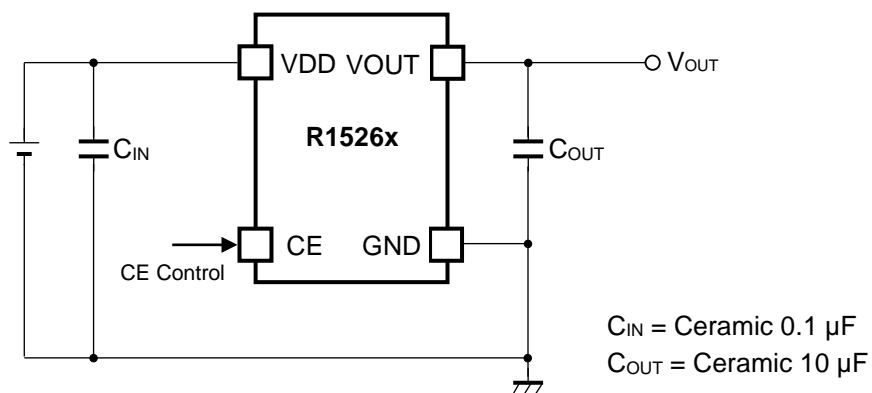
Test Circuit**Test Circuit for Typical Characteristics****Measurement Components**

Symbol	Specification	Measurement Item	Manufacturer	Parts Number
C_{IN}	0.1 μF	11,12,14,15	TDK	CGA4J2X7R1H104K
C_{OUT}	10 μF	All Items	TDK	CGA4J1X7S1C106K

Measurement Components of Typical Characteristics

The power dissipation of the package is dependent on PCB material, layout, and environmental conditions. The following measurement conditions are based on JEDEC STD. 51-7.

Measurement Conditions

Item	Measurement Conditions
Environment	Mounting on Board (Wind Velocity = 0 m/s)
Board Material	Glass Cloth Epoxy Plastic (Four-Layer Board)
Board Dimensions	76.2 mm × 114.3 mm × 0.8 mm
Copper Ratio	Outer Layer (First Layer): Less than 95% of 50 mm Square Inner Layers (Second and Third Layers): Approx. 100% of 50 mm Square Outer Layer (Fourth Layer): Approx. 100% of 50 mm Square
Through-holes	φ 0.3 mm × 21 pcs

Measurement Result

(Ta = 25°C, Tjmax = 125°C)

Item	Measurement Result
Power Dissipation	2900 mW
Thermal Resistance (θja)	θja = 34.5°C/W
Thermal Characterization Parameter (ψjt)	ψjt = 10°C/W

θja: Junction-to-ambient thermal resistance.

ψjt: Junction-to-top of package thermal characterization parameter

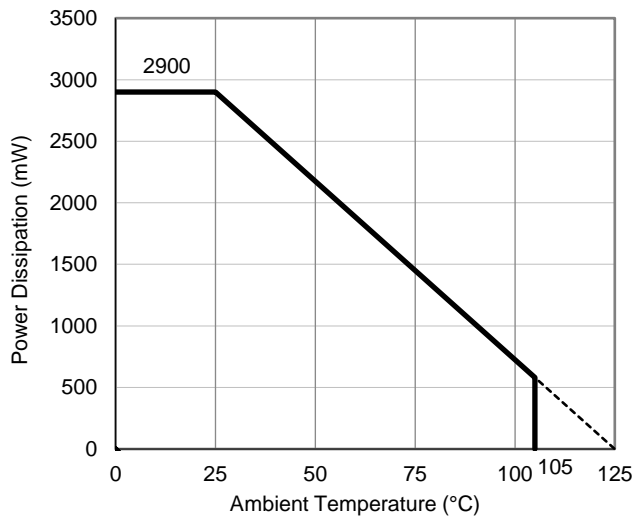

Power Dissipation vs. Ambient Temperature

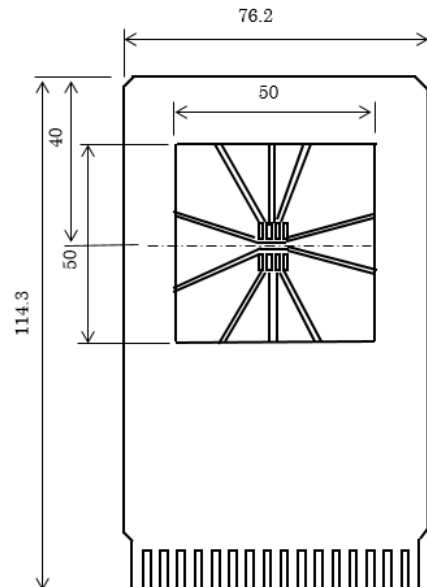

Measurement Board Pattern

PACKAGE DIMENSIONS

HSOP-8E

DM-HSOP-8E-JE-B

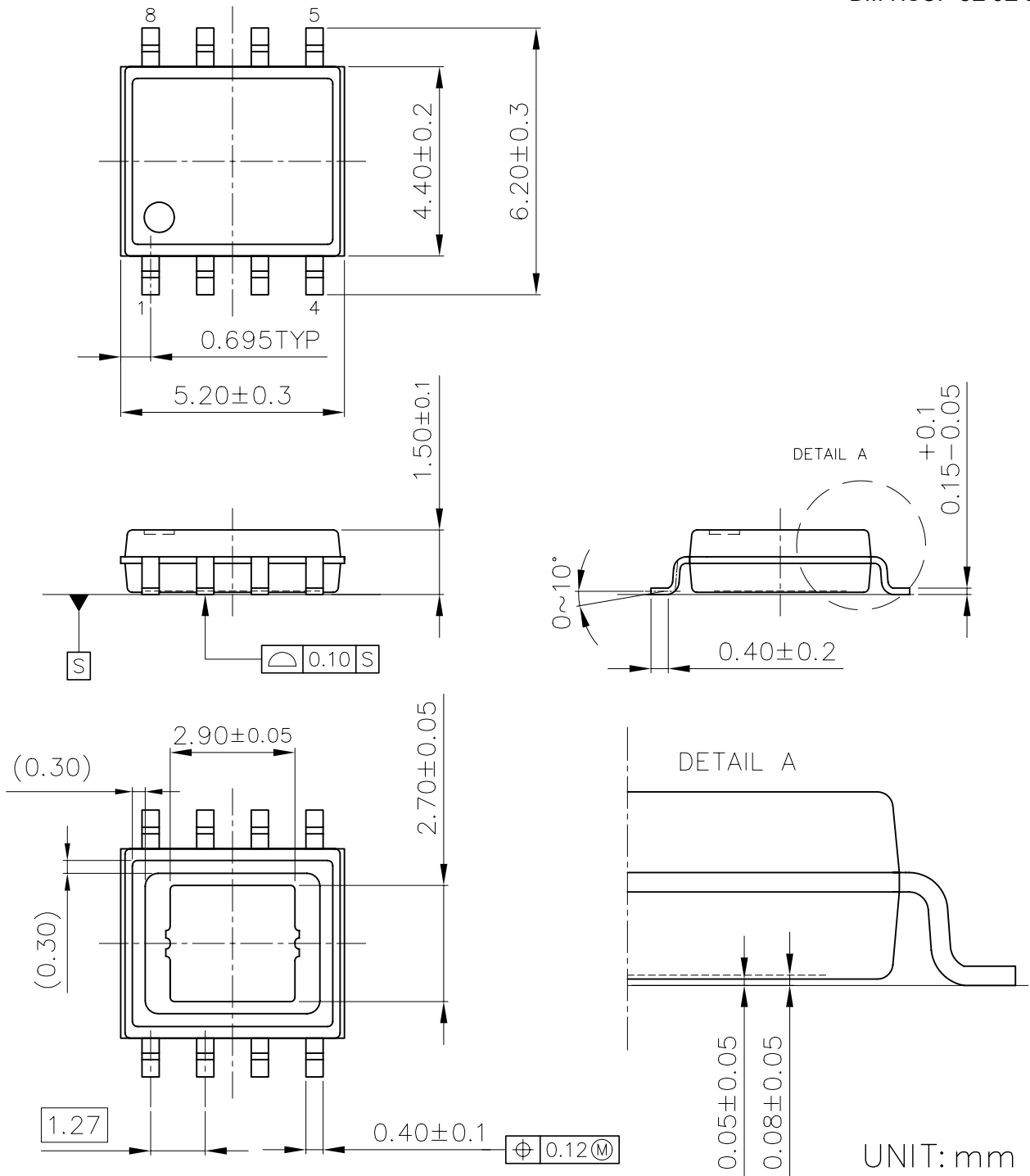

HSOP-8E Package Dimensions



1. The products and the product specifications described in this document are subject to change or discontinuation of production without notice for reasons such as improvement. Therefore, before deciding to use the products, please refer to Ricoh sales representatives for the latest information thereon.
2. The materials in this document may not be copied or otherwise reproduced in whole or in part without prior written consent of Ricoh.
3. Please be sure to take any necessary formalities under relevant laws or regulations before exporting or otherwise taking out of your country the products or the technical information described herein.
4. The technical information described in this document shows typical characteristics of and example application circuits for the products. The release of such information is not to be construed as a warranty of or a grant of license under Ricoh's or any third party's intellectual property rights or any other rights.
5. The products listed in this document are intended and designed for use as general electronic components in standard applications (office equipment, telecommunication equipment, measuring instruments, consumer electronic products, amusement equipment etc.). Those customers intending to use a product in an application requiring extreme quality and reliability, for example, in a highly specific application where the failure or misoperation of the product could result in human injury or death (aircraft, spacevehicle, nuclear reactor control system, traffic control system, automotive and transportation equipment, combustion equipment, safety devices, life support system etc.) should first contact us.
6. We are making our continuous effort to improve the quality and reliability of our products, but semiconductor products are likely to fail with certain probability. In order to prevent any injury to persons or damages to property resulting from such failure, customers should be careful enough to incorporate safety measures in their design, such as redundancy feature, fire containment feature and fail-safe feature. We do not assume any liability or responsibility for any loss or damage arising from misuse or inappropriate use of the products.
7. Anti-radiation design is not implemented in the products described in this document.
8. The X-ray exposure can influence functions and characteristics of the products. Confirm the product functions and characteristics in the evaluation stage.
9. WLCSP products should be used in light shielded environments. The light exposure can influence functions and characteristics of the products under operation or storage.
10. There can be variation in the marking when different AOI (Automated Optical Inspection) equipment is used. In the case of recognizing the marking characteristic with AOI, please contact Ricoh sales or our distributor before attempting to use AOI.
11. Please contact Ricoh sales representatives should you have any questions or comments concerning the products or the technical information.



Ricoh is committed to reducing the environmental loading materials in electrical devices with a view to contributing to the protection of human health and the environment.

Ricoh has been providing RoHS compliant products since April 1, 2006 and Halogen-free products since April 1, 2012.

RICOH RICOH ELECTRONIC DEVICES CO., LTD.

Official website

<https://www.n-redc.co.jp/en/>

Contact us

<https://www.n-redc.co.jp/en/buy/>

